

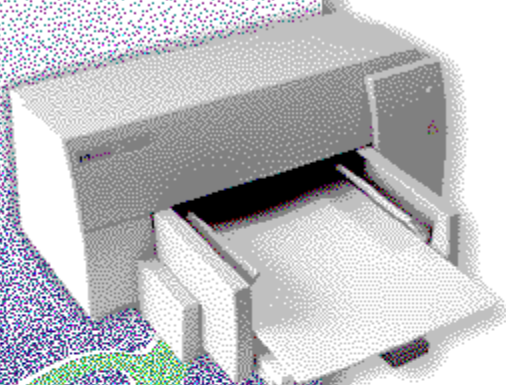

HP DeskJet 600 Series



Printer Information



- HP Printing System
- Windows and Dialog Boxes
- Optimizing Printer Performance
- Printing Tips
- Using Paper and Print Cartridges
- If You Have a Printing Problem

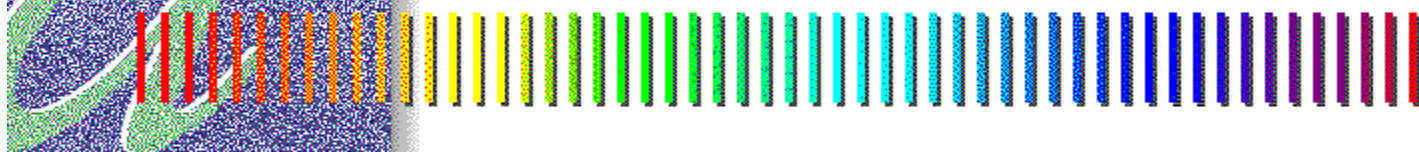

HP Printing System

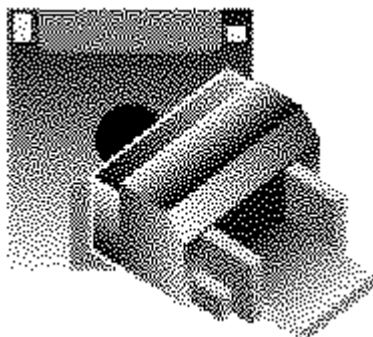

- [About the Printer](#)
- [About the Printer Software](#)

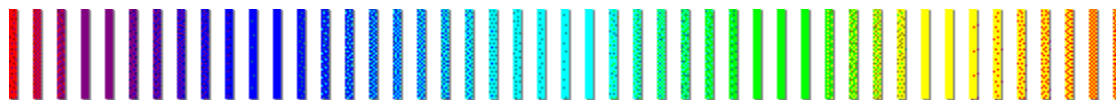

Windows and Dialog Boxes

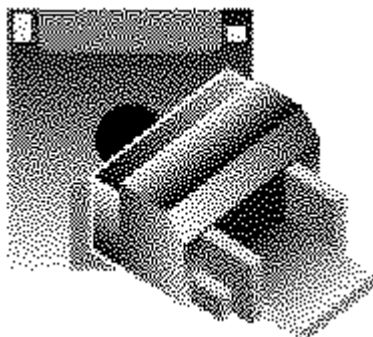

- ColorSmart Dialog Box
 - ColorSmart Options Dialog Box
 - HP DeskJet Status Monitor
- Window

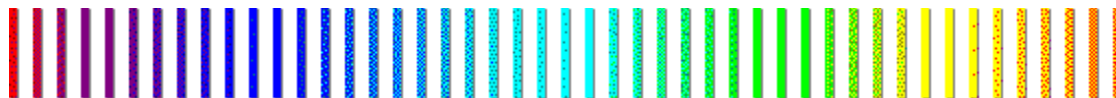

Optimizing Printer Performance

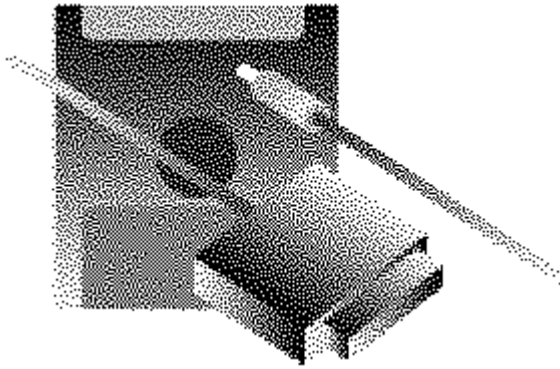

- Increasing Printer Performance
- Updating the Printer Software
- Using EconoFast
- Automatic vs. Manual ColorSmart Option
- Color Printing vs. Black Printing (HP DeskJet 600 Printer Only)

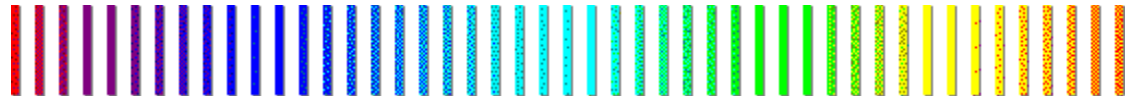

[Contents](#)

Printing Tips

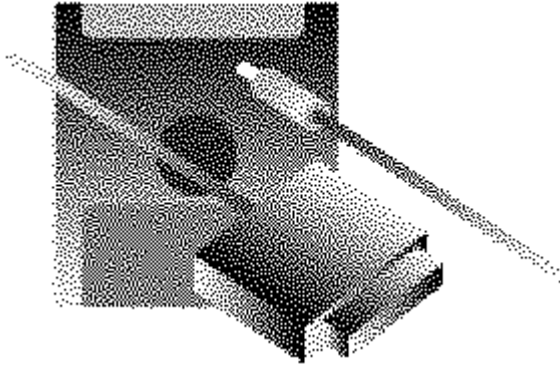

- [Printing Presentation Slides](#)
- [Printing on Envelopes](#)
- [Printing on Custom Paper Sizes](#)
- [Printing on HP Premium Papers](#)
- [Printing in Grayscale](#)
- [Using Color](#)



 [Contents](#)

Using Paper and Print Cartridges

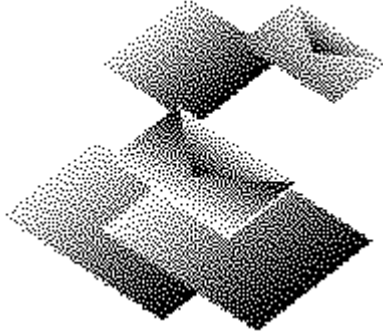

 Installing Paper and Other Media

 Installing Print Cartridges

Aligning Print Cartridges

Cleaning Print Cartridges



Contents

If You Have a Printing Problem

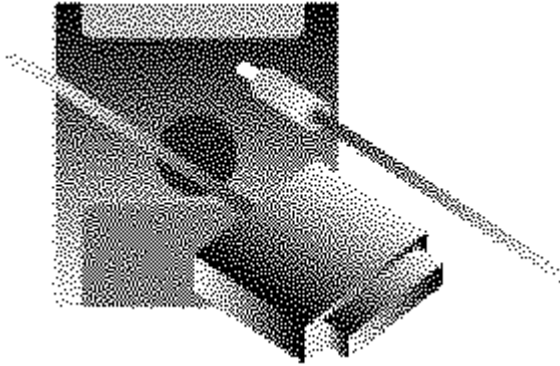

Go to Dr. DeskJet

Doing a Performance Checkup

Checking Printer Buttons and
Lights

Getting Help from HP

About the Printer

.....

The HP DeskJet 600 Series of printers includes the HP DeskJet 600 and the HP DeskJet 660C. The HP DeskJet 600 printer is a monochrome printer that is color-capable. This means that it can print in color once the optional HP Color Kit has been installed. The HP DeskJet 660C printer is a color printer; it does not need any extra accessories to print in color.

As you read through the information in this system, make sure that you look for notes that address your specific printer.

.....

.....
Supported Paper Types

.....
About the Print Cartridges

.....
Printer Buttons and Lights

[Contents](#)

[HP](#)

[Printing System](#)

[About](#)

[the Printer](#)

Supported Paper Types

Your HP DeskJet 600 Series printer supports the following paper types and media types:

 [Printing Tips](#)

Bond paper

Photocopier paper

Envelopes

HP Premium InkJet Paper

HP Premium Transparency Film

HP Premium Glossy Paper

Note: It is important that you select the correct Paper Type setting in the ColorSmart dialog box.

 [ColorSmart Dialog Box](#)





[Contents](#)



[HP Printing System](#)



[About the Printer](#)

About the Print Cartridges



The HP DeskJet 660C printer comes standard with both a black print cartridge and a color print cartridge. The HP DeskJet 600 printer comes standard with only a black print cartridge, but a color print cartridge can be used if you purchase the optional HP Color Kit.



[HP Color Kit \(HP DeskJet 600 printer only\)](#)

To maintain excellent print quality from your print cartridges:

- Turn off the printer and allow the print cartridges to return to the right side of the printer before you unplug the power cord.
- Keep all print cartridges in their sealed packages; store them at room temperature (60° - 78°F or 15.6° - 26.6°C) until you are ready to use them.





[Contents](#)



[HP Printing System](#)



[About the Printer](#)

Printer Buttons and Lights



Your HP DeskJet 600 Series printer has two lights and two buttons to control power and printing and to provide information about printer status.



[Checking Printer Buttons and Lights](#)



Resume light

Flashes when the printer needs attention.

Resume button

Press this button to return the printer to the ready-to-print state.



Power light

Lights when the printer is receiving power; flashes when receiving information from the computer or when printing.

Power button

Press this button to turn the printer on or off.

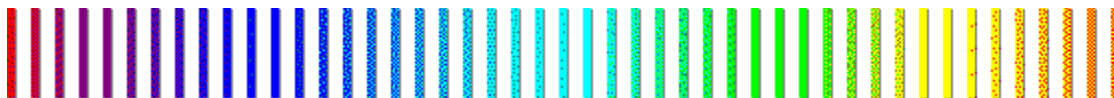

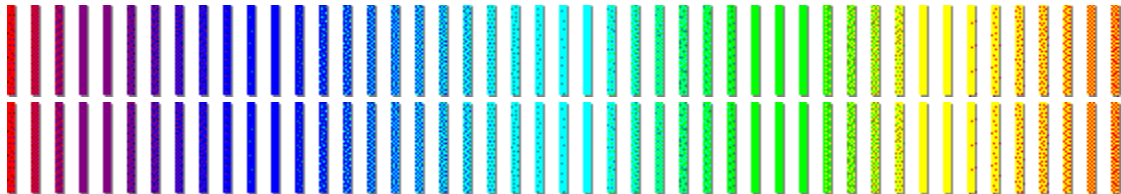

[Printing System](#)

[Contents](#)

[HP](#)

About the Printer Software

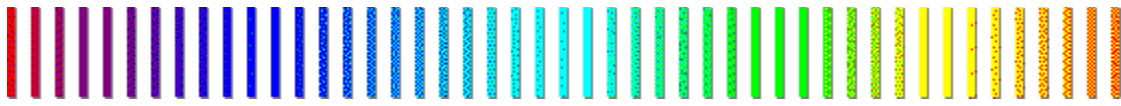

The software provided with your HP DeskJet 600 Series printer includes a printer driver, the HP DeskJet Status Monitor, several TrueType fonts, Release Notes, and this online Help system. It also includes Dr. DeskJet to assist in diagnosing and solving printing problems.

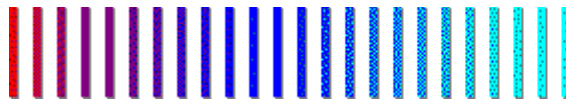

[About the HP DeskJet Status Monitor](#)

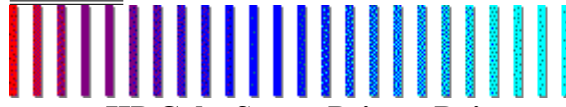

[HP ColorSmart Printer Driver](#)

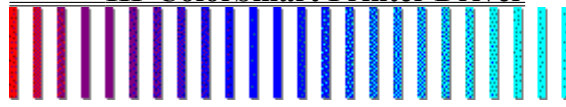

[About Dr. DeskJet](#)

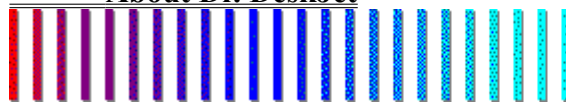

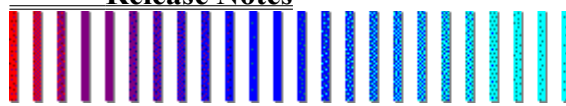

[Release Notes](#)

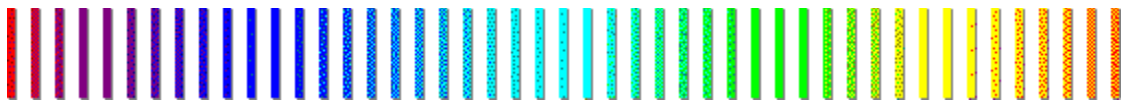

[TrueType Fonts](#)

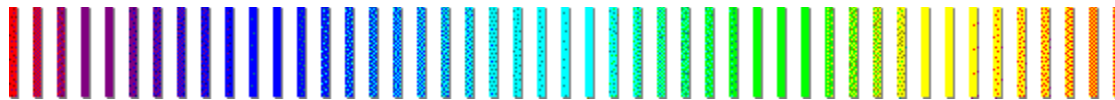
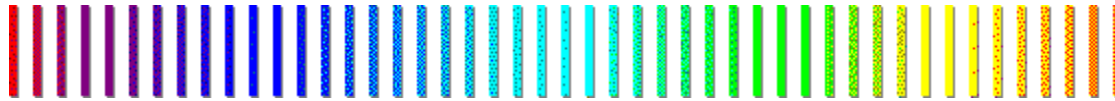
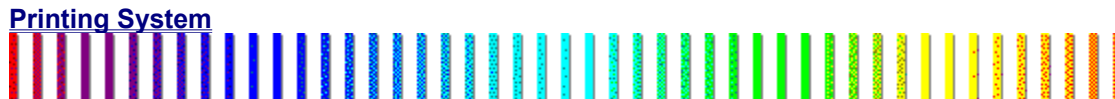

| | |
|--|----------------------------------|
|  | Contents |
|  | HP |
|  | Printing System |
|  | Printer Software |
|  | About the |

About the HP DeskJet Status Monitor

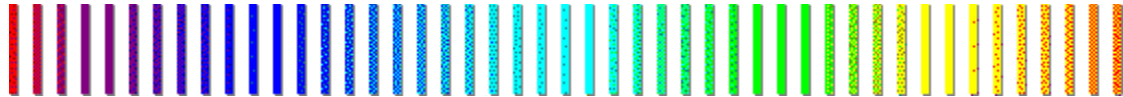

The HP DeskJet Status Monitor provides information about the current print job and the current state of the printer. It also lets you do certain printer tasks, such as cleaning and aligning the print cartridges and printing a self-test page.

The Status Monitor will open automatically when you send a document to print or when a printing error occurs that needs your attention before printing can resume. You can also access the Status Monitor by double-clicking on the HP DeskJet Status Monitor icon located in the HP DeskJet Utilities program group in the Program Manager.

With the HP DeskJet Status Monitor, you can:

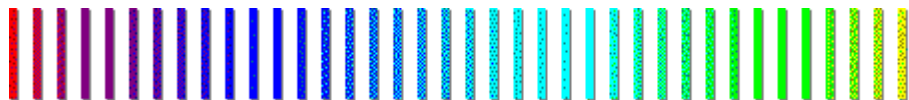

monitor a current print job

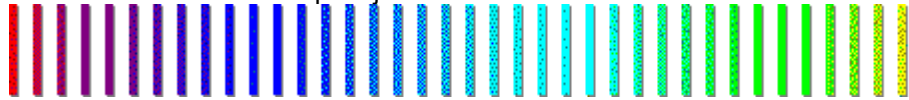

monitor the printer's status at any time

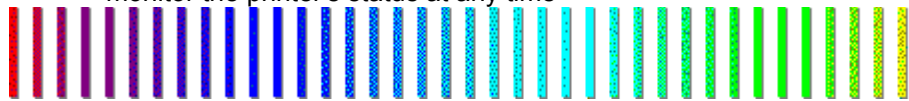

clean the print cartridges

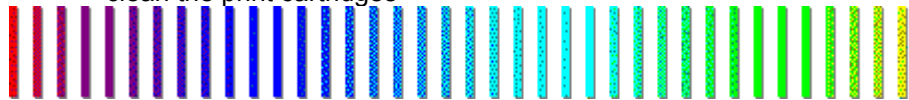

align the print cartridges

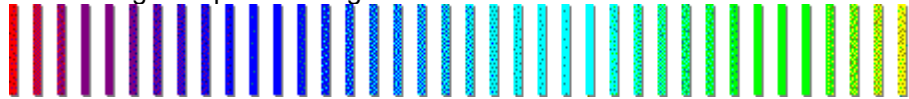

cancel the current print job

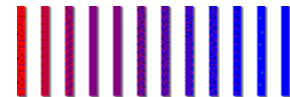

[HP DeskJet Status Monitor Window](#)

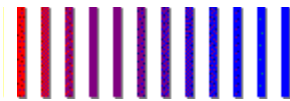

[Cleaning Print Cartridges](#)

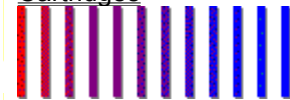

[Aligning Print Cartridges](#)

Note: The HP DeskJet Status Monitor always reappears either as a full-size window or as an icon. You can restore the icon to a full-size window or minimize the window to an icon.

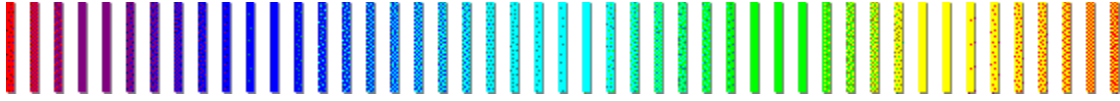

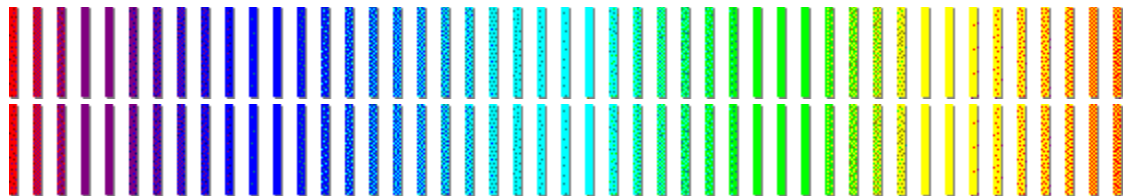

| | |
|----------------------------------|---------------------------|
| | Contents |
| | HP |
| Printing System | |
| Printer Software | About the |

HP ColorSmart Printer Driver

A printer driver is a software program that allows you to access printer features from a software program, such as a word-processing or spreadsheet program. You use the printer driver to select the ColorSmart option (automatic or manual), print quality, page orientation, paper type, and paper size.

The HP ColorSmart technology within the HP printer driver analyzes your documents and automatically adjusts the color settings to produce the best possible color output. Although ColorSmart will provide you with the best print quality, you can manually override the settings at any time by selecting the Manual ColorSmart option in the ColorSmart dialog box.

▶ To use ColorSmart

- In the ColorSmart dialog box, select Automatic. ColorSmart automatically selects the proper color settings for your document.

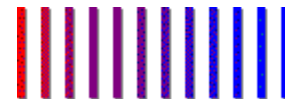

[Automatic vs. Manual ColorSmart Option](#)

▶ To override ColorSmart

- 1 In the ColorSmart dialog box, select Manual.
- 2 Choose the Options button.
- 3 In the ColorSmart Options dialog box, select the [Halftoning](#), [Intensity](#), and [Color Control](#) settings you want.

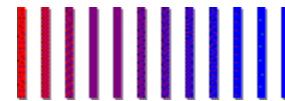

[ColorSmart Dialog Box](#)

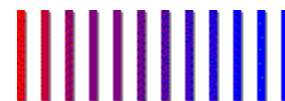

[ColorSmart Options Dialog Box](#)

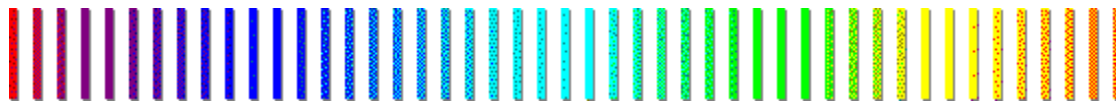

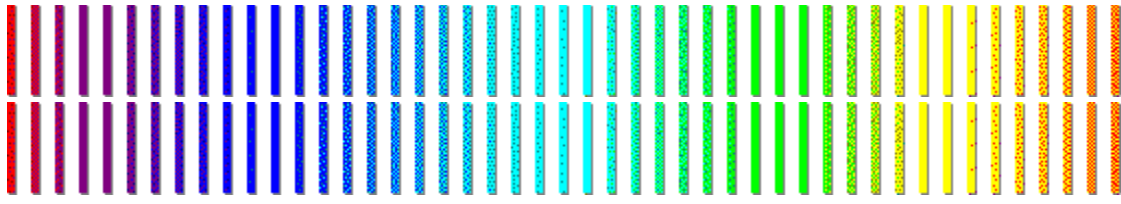

[Contents](#)

[HP](#)

[Printing System](#)

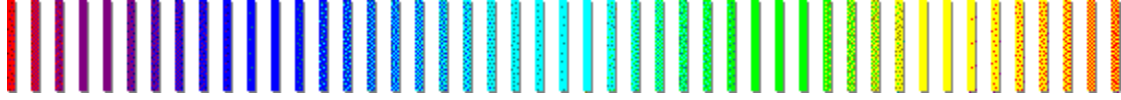

[About the](#)

[Printer Software](#)

About Dr. DeskJet

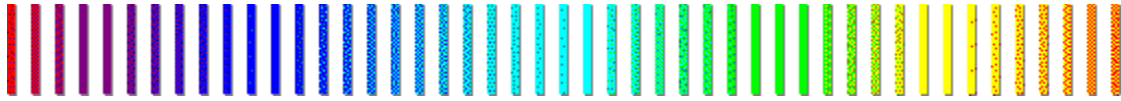

Dr. DeskJet provides step-by-step instructions for solving the most common printing problems. You simply answer a series of questions, and Dr. DeskJet guides you through the possible solutions to your printing problem.



[Go to Dr. DeskJet](#)

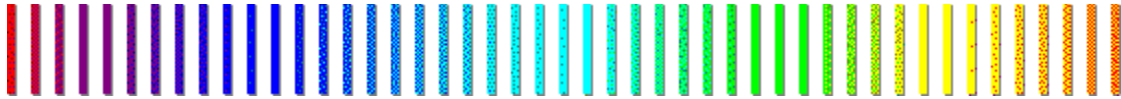

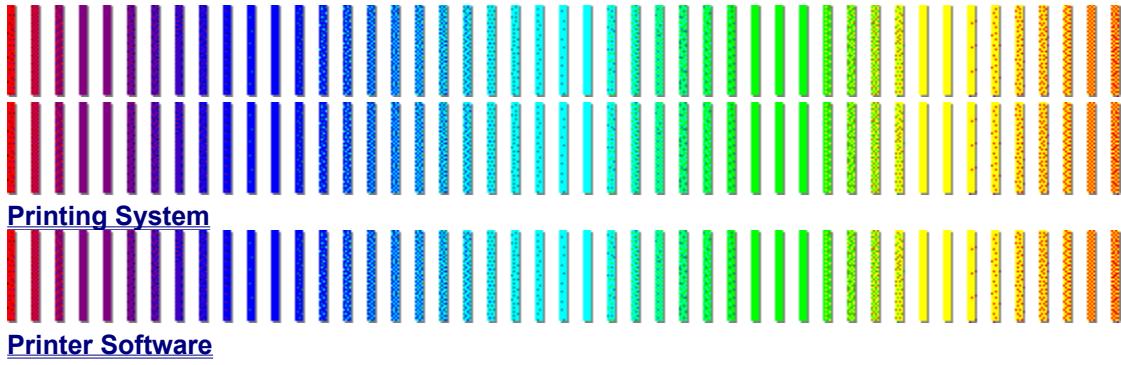

| | |
|----------------------------------|---------------------------|
| Printing System | Contents |
| Printer Software | HP |
| | About the |

Release Notes

The Release Notes contain information about the printer driver and known hardware and software conflicts. This late-breaking information was not available in time to be included in the user's guide or this online Help system.

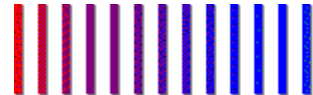

[Go to Release Notes](#)

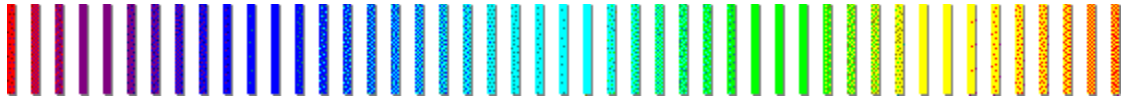

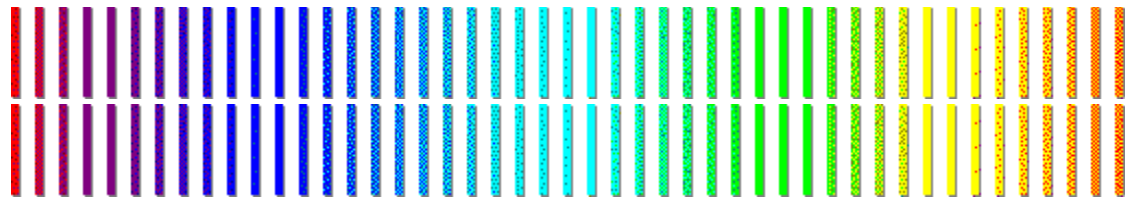

[Printing System](#)

[Printer Software](#)

[Contents](#)

[HP](#)









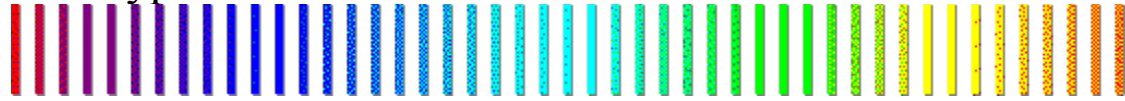





























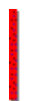







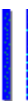
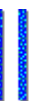
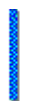

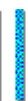
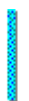

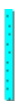

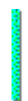
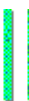
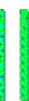
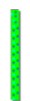





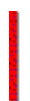





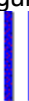

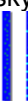
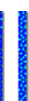
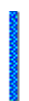

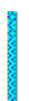

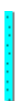

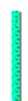
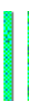
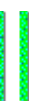
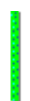

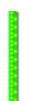





























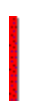







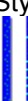
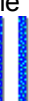
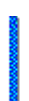

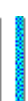
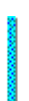

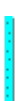

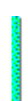
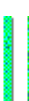
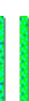
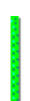

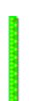

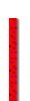





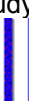

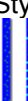
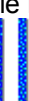
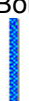

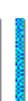
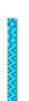
[About the](#)

TrueType Fonts

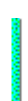
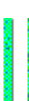
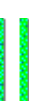
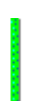
TrueType is a scalable typeface technology included with Windows 3.1 that creates fonts "on the fly" and provides WYSIWYG (What You See Is What You Get) output by using the same typefaces for both the screen and printer. TrueType fonts will work in all Windows software applications; these fonts can be identified by the TrueType icon next to the font name in the application's Font pull-down list box or in the Fonts dialog box in the Control Panel.

Several scalable TrueType fonts are supplied with your HP DeskJet 600 Series printer, providing you greater flexibility for making typeface an important page element. You should have installed these fonts when you installed your printer software. The fonts supplied with your HP DeskJet 600 Series printer range from serious to stylistic to fun:



| | | | | | | | | | | | | | | | | | | | | | | | | | | | |
|---|---|---|---|---|---|---|---|---|---|---|---|---|---|---|---|---|---|---|---|---|---|---|---|---|--|---|---|
|  |  |  |  |  |  |  |  |  |  |  |  |  |  |  |  |  |  |  |  |  |  |  |  |  |  |  |  |
| Arial Black | | | | | | | | | | | | | | | | | | | | | | | | | | | |
|  |  |  |  |  |  |  |  |  |  |  |  |  |  |  |  |  |  |  |  |  |  |  |  |  |  |  |  |
| PL Benguiat Frisky | | | | | | | | | | | | | | | | | | | | | | | | | | | |
|  |  |  |  |  |  |  |  |  |  |  |  |  |  |  |  |  |  |  |  |  |  |  |  |  |  |  |  |
| Gill Sans Shadow | | | | | | | | | | | | | | | | | | | | | | | | | | | |
|  |  |  |  |  |  |  |  |  |  |  |  |  |  |  |  |  |  |  |  |  |  |  |  |  |  |  |  |
| CG Goudy Old Style | | | | | | | | | | | | | | | | | | | | | | | | | | | |
|  |  |  |  |  |  |  |  |  |  |  |  |  |  |  |  |  |  |  |  |  |  |  |  |  |  |  |  |
| CG Goudy Old Style Bold | | | | | | | | | | | | | | | | | | | | | | | | | | | |
|  |  |  |  |  |  |  |  |  |  |  |  |  |  |  |  |  |  |  |  |  |  |  |  |  |  |  |  |
| CG Goudy Old Style Italic | | | | | | | | | | | | | | | | | | | | | | | | | | | |

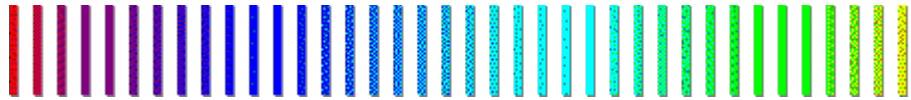

Graphite Light

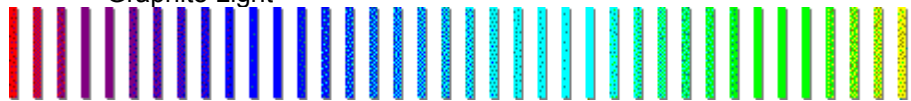

Graphite Light Narrow

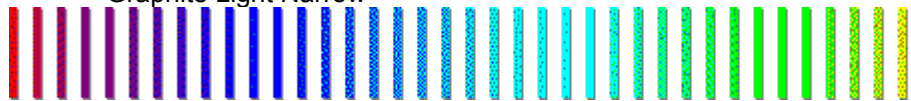

Lucida Casual

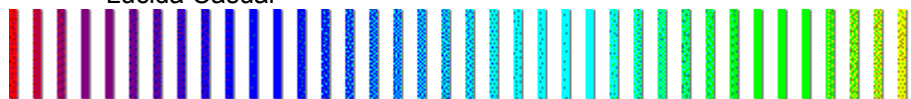

Lucida Casual Italic

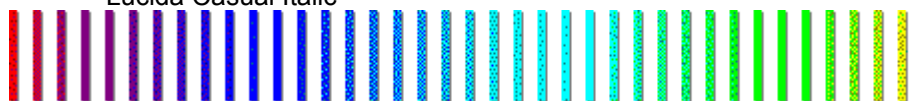

Milestones

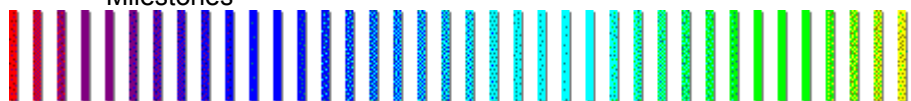

Phyllis

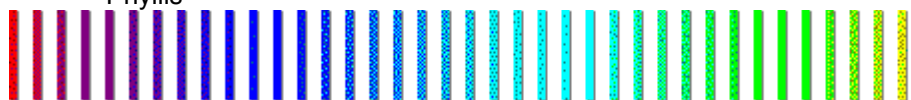

CG Poster Bodoni

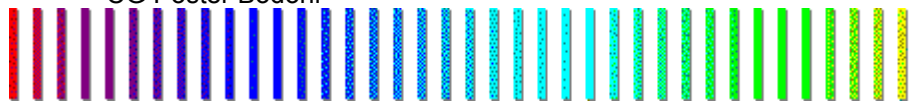

Signet Roundhand

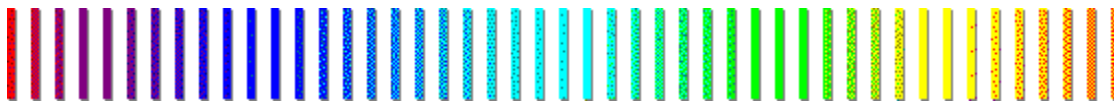

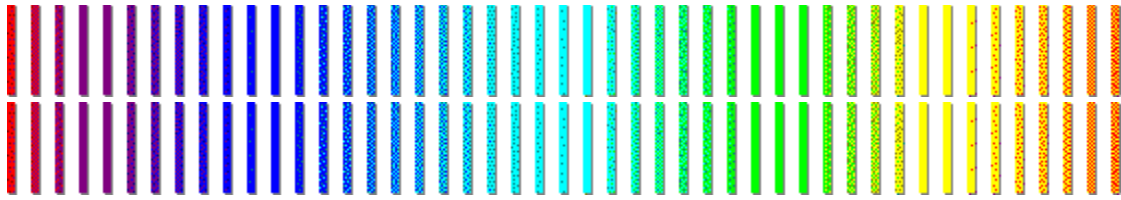

[Contents](#)

[Windows](#)

[and Dialog Boxes](#)

ColorSmart Dialog Box

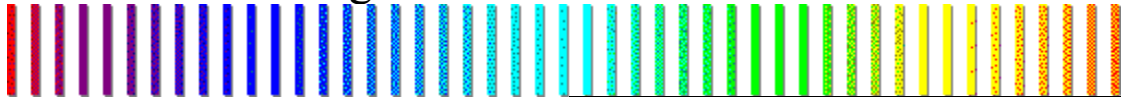

Selecting Print Settings

Use this dialog box to specify how you want your job to be printed.

[Automatic](#)
[Manual](#)
[Print in Grayscale](#)
[Options Button](#)

[Best](#)
[Normal](#)
[EconoFast](#)

[Paper Type](#)

[Paper Size](#)
[Custom Button](#)

[Status Bar](#)

[Portrait](#)
[Landscape](#)

[Copies](#)
[Ordered Printing](#)

[OK Button](#)
[Cancel Button](#)
[Default Button](#)
[Help Button](#)

[ICM \(Image Color Matching\)](#)

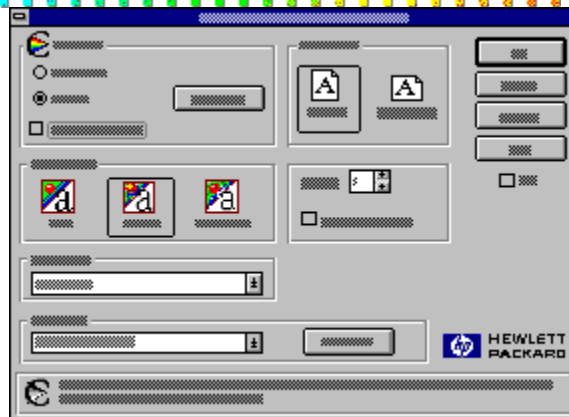

ColorSmart Options Dialog Box

[Automatic vs. Manual ColorSmart Option](#)

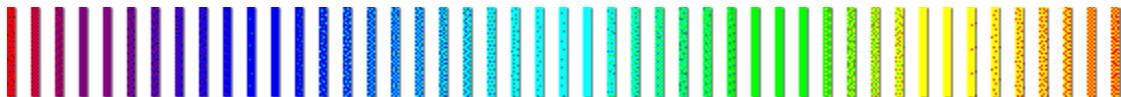



Automatic

This is the recommended setting for all documents.

The Automatic option uses ColorSmart technology to automatically select the best Halftoning, Intensity, and Color Control settings for both graphics and text.

 **Manual**

Select this option to manually select the Halftoning, Intensity, and Color Control settings for both graphics and text. After you select this option, choose the Options button to change the settings displayed in the ColorSmart Options dialog box.



Print in Grayscale

Select this check box for grayscale printing of color images. With grayscale imaging, colors and saturation levels of color are represented as different shades of gray.



Best

Best mode produces the highest print quality for all media and eliminates the banding effect that sometimes occurs in solid areas. However, the Best setting prints more slowly than Normal mode for most documents.



Normal

Letter-quality printing. Normal mode delivers high-quality output. Normal is the default print quality setting for most paper types.



EconoFast

Draft-quality printing. EconoFast mode prints faster than the Normal setting and delivers comparable output. Using EconoFast will also cut down on the frequency of replacing your print cartridges because it uses less ink.

EconoFast printing is available only when you select plain paper or transparencies as the paper type.

Note: For printing drafts of color documents, select EconoFast and the Print in Grayscale check box. This usually prints faster, using grayscale instead of color.



Portrait

Prints across the width of the page (letter style).



Landscape

Prints across the length of the page (spreadsheet style).

Paper Type

Select the Paper Type setting that matches the paper or other media type you are using in your printer.

Note: Certain paper types (or other media types) may not be compatible with your printer. Use only paper types listed in the ColorSmart dialog box for your printer. For more information about media types, see your printer user's guide.

Paper Size

Select the size of the paper or other media you have loaded in your printer. Use only paper sizes that are listed in the ColorSmart dialog box for your printer.



Copies

Type the number of copies you want to print, or click the up arrow or the down arrow to select the number of copies.



Ordered Printing

Select this check box to print the pages of your document in reverse order (last page first). When your document is printed, the pages will be ordered first to last. If you are printing multiple copies, selecting Ordered Printing collates the pages. Ordered printing slows printing time.

Default Button

Choose the Default button to return all of the settings in the dialog box to their default values.

Options Button

Choose the Options button in the ColorSmart dialog box to select Intensity settings, Halftoning methods, and Color Control options.

Note: When the Automatic option is selected in the ColorSmart dialog box, the Options button is disabled (grayed out), and the printer software determines the Intensity, Halftoning, and Color Control settings.

Custom Button

Choose the Custom button to specify a custom paper size in the Custom Paper Size dialog box.

OK Button

Choose the OK button to close the dialog box, saving any changes you have made.

Cancel Button

Choose the Cancel button to close the dialog box without saving the changes you have made.

Help Button

Choose the Help button to open the Help file.

ICM (Image Color Matching)

Check the ICM check box to improve consistency between the printer and other color devices connected to your system.

Status Bar

The status bar gives a brief description of the option currently highlighted in the dialog box.

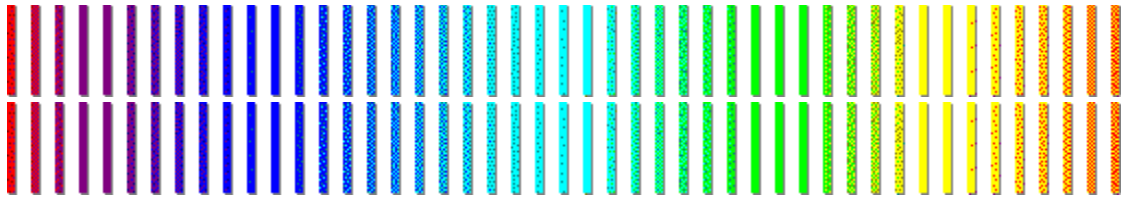

[and Dialog Boxes](#)

[Contents](#)

[Windows](#)

ColorSmart Options Dialog Box

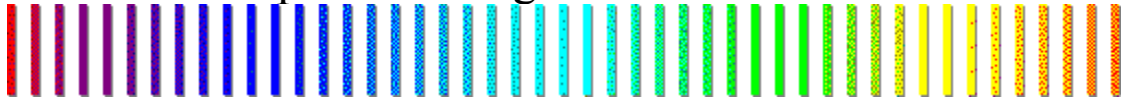

Selecting ColorSmart Options

To display the ColorSmart Options dialog box, select Manual in the ColorSmart dialog box, and then choose the Options button. Use the ColorSmart Options dialog box to select the exact color settings you want for your print job.

[Intensity](#)

[Pattern Halftoning](#)

[Scatter Halftoning](#)

[Vivid Color](#)

[Match Screen](#)

[OK Button](#)

[Cancel Button](#)

[Default Button](#)

[Help Button](#)

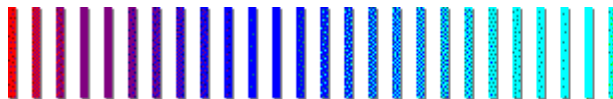
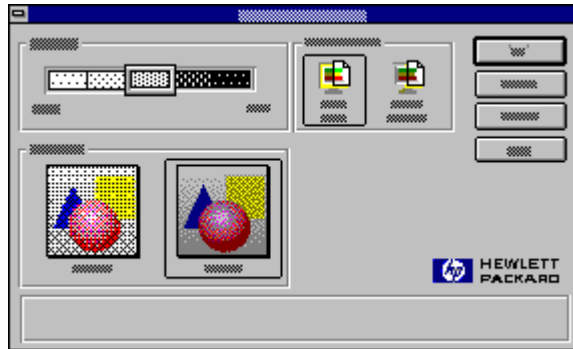

[ColorSmart Dialog Box](#)

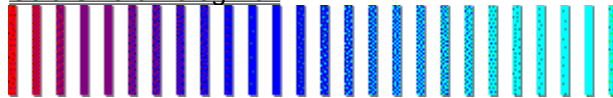

[Automatic vs. Manual ColorSmart Options](#)

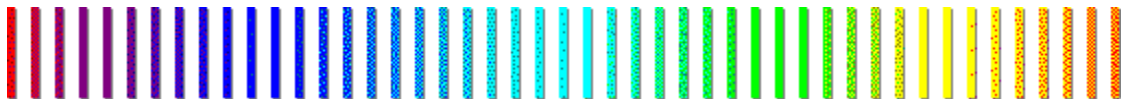

Scatter

This is the recommended setting for most documents. Scatter halftoning places dots of ink in a random manner.

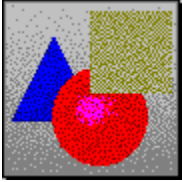

Pattern

Pattern halftoning places dots of ink in geometric patterns. Documents with simple graphics may print faster with the Pattern setting.

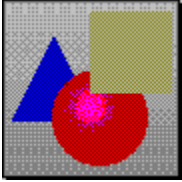



Vivid Color

Use this Color Control setting to print clear and vivid colors. Select the Vivid Color option for simple, solid color graphics and for software applications that support the eight basic colors (black, white, red, green, blue, cyan, yellow, and magenta).

Note: Color Control settings are not available if you are printing in grayscale.



Match Screen

Use this Color Control setting to adjust printed colors to best match your screen. Select the Match Screen option for complex color graphics, such as scanned images, photographs, and complex computer-generated artwork.

Note: Color Control settings are not available if you are printing in grayscale.

Intensity

Use the Intensity slider to control the amount of ink printed on a page. With the mouse, move the slider to the left for lighter images (less ink), or to the right for darker images (more ink).



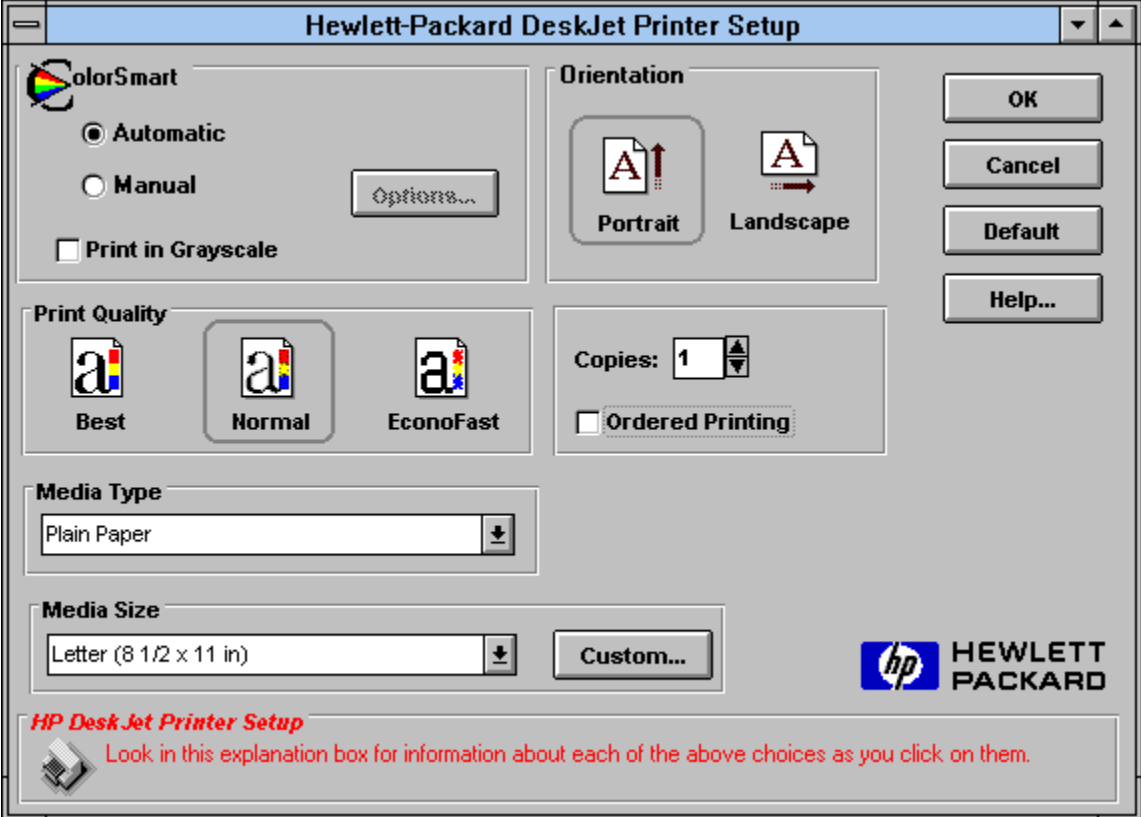

Halftoning

The method by which the three colors from a color print cartridge are combined to produce millions of colors.

Scatter halftoning places dots of ink in a random manner. This is the recommended setting for most documents.

Pattern halftoning places dots of ink in geometric patterns. Documents with simple graphics may print faster with the Pattern setting.

Intensity

The amount of color printed on a page. The more intense, or saturated, the colors are, the more vivid they are.

Color Control

There are two Color Control settings: Vivid Color and Match Screen.

The *Vivid Color* setting prints clear and vivid colors. Select the Vivid Color option for simple, solid color graphics and for software applications that support the eight basic colors (black, white, red, green, blue, cyan, yellow, and magenta).

The *Match Screen* setting adjusts printed colors to best match the colors on your screen. Select the Match Screen option for complex color graphics, such as scanned images, photographs, and complex computer-generated artwork.

Note: Color Control settings are not available if you are printing in grayscale.

Media

The paper or other material on which you are printing. Paper, transparency film, and envelopes are examples of media.

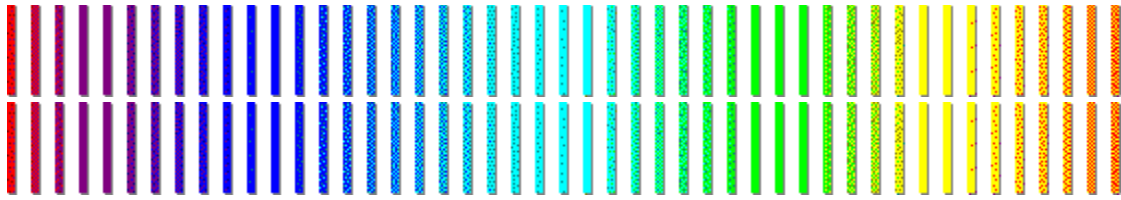

and Dialog Boxes

Contents

Windows

HP DeskJet Status Monitor Window

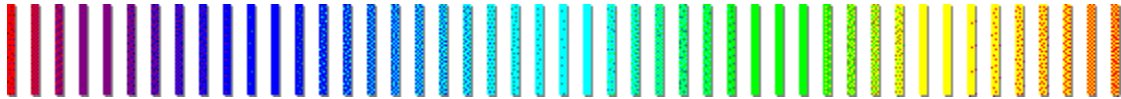

The HP DeskJet Status Monitor window provides information about the current print job and the current state of the printer. The Status Monitor can also be used to perform other printer tasks, such as cleaning and aligning the print cartridges.



To use the HP DeskJet Status Monitor, Double-click the HP DeskJet Status Monitor icon in the HP DeskJet Utilities program group.

Printer Menu

Options Menu

Maintenance Menu

Test Menu

Help Menu

Printer Status Box

Cancel Button

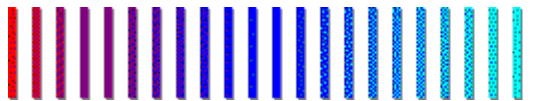
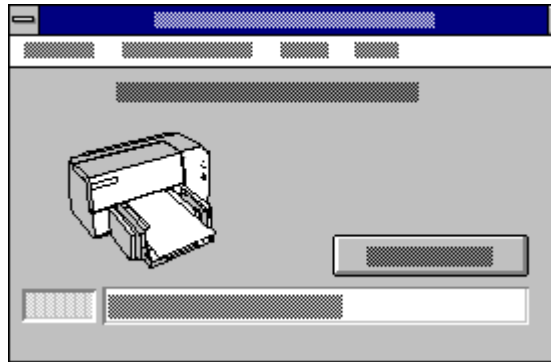

About the HP DeskJet Status Monitor

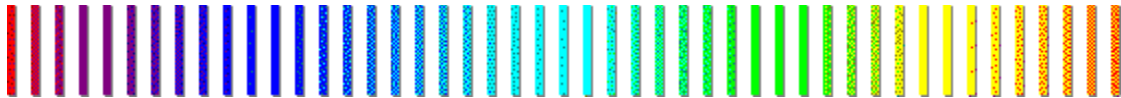

Printer Menu

The Printer menu lists all of the HP DeskJet printers that are connected to your computer.

Options Menu

The Options menu lets you select when the HP DeskJet Status Monitor is displayed, and turn on or turn off an audio alert for error conditions. To select a setting, click the setting you want in the menu. A check mark appears next to the selected item.

- | | |
|------------------------------|---|
| Display Always | When checked, the HP DeskJet Status Monitor is displayed in the state that it was last used (an icon or a window) whenever you start Windows. |
| Display When Printing | When checked, the HP DeskJet Status Monitor is displayed only when a document is printing. |
| Audio Alert | When checked, an audible alert sounds whenever a printer error is detected. |

Maintenance Menu

The Maintenance menu contains the following commands:

- | | |
|-------------------------------|---|
| Clean Print Cartridges | Cleans the print cartridges. Perform a print cartridge cleaning when print quality has noticeably decreased, or when HP Help messages have recommended doing so. |
| Align Print Cartridges | Aligns the color and black print cartridges. Perform a print cartridge alignment whenever you have replaced or reinstalled a print cartridge, or when other HP Help messages have recommended doing so. |

Test Menu

The Test menu contains the following commands:

- | | |
|---------------------------|--|
| Print a Self Test | Performs a printer self-test. Do this to verify that the printer is working properly and that the cable connection is at least at minimum standards. |
| Show Configuration | Displays printer configuration information. |

Help Menu

The Help menu contains the following commands:

- | | |
|--|---|
| Contents | Displays information about how to use the HP DeskJet Status Monitor window. |
| Using HP DeskJet Status Monitor | Displays general information about the HP DeskJet Status Monitor. |
| About HP DeskJet Status Monitor | Displays program information, HP DeskJet Status Monitor version, and copyright. |

Printer Status Box

This box displays a message that indicates the current status of the printer.

Cancel Button

Press this button to cancel the current print job.

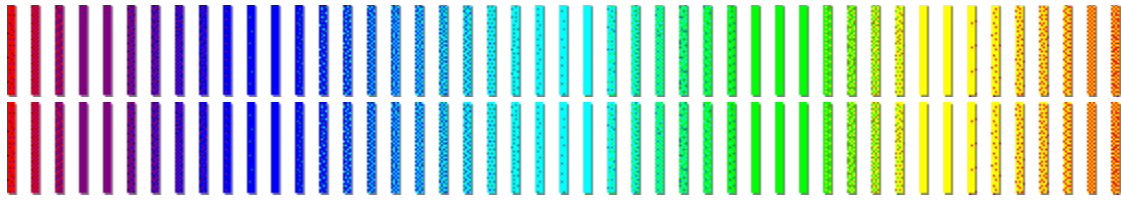

Optimizing Printer Performance

Increasing Printer Performance

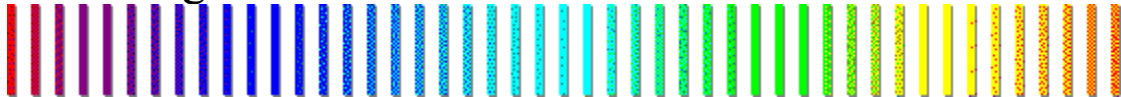

The print speed and overall performance of your printer can be affected by several things:

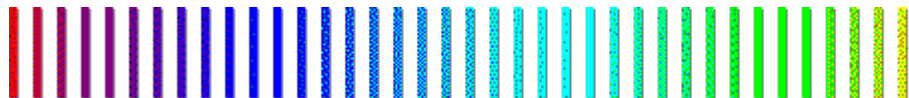

The amount of RAM in your computer can determine how fast your documents are sent to the printer. Increasing the amount of RAM in your computer can speed up this process as well as make your computer work more efficiently when you are doing other things besides printing.

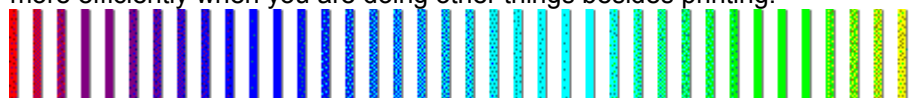

The printer driver that you are using to print your documents can make a significant difference in the quality of your printed output. Make sure you are using an up-to-date version of an HP printer driver designed specifically for your printer model. To check this, open the Printers Control Panel and make sure your printer is selected in the Installed Printers list. Click Setup to check the version you are using. The version number is located in the title bar of the HP ColorSmart dialog box.

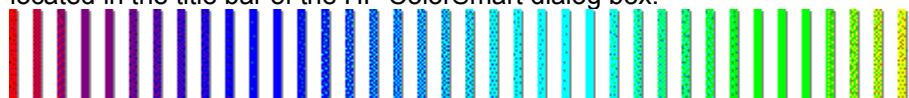

The size and complexity of the documents you print can make a difference in your printer's performance. Graphics are usually more complex and print more slowly than a file that contains only text.

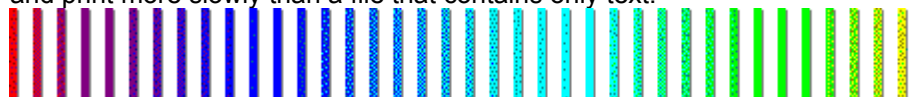

The processing speed of your computer will determine how fast your document is sent to the printer. For example, a computer with a 486 processor will run faster than a computer with a 386 or a 286 processor.

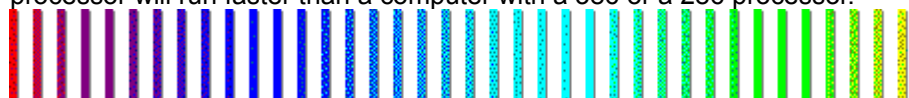

Running numerous software programs at one time will slow down printing, because they are using the RAM in your computer. Therefore, limit the number of programs or documents you open at one time.

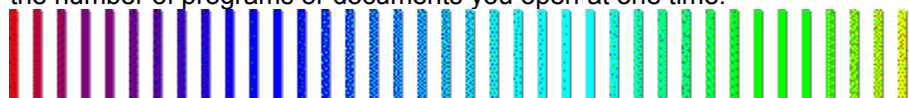

Screen fonts are stored in RAM, which means they use up memory

that the printer may need in order to print. Delete screen fonts or printer fonts that you do not use often.

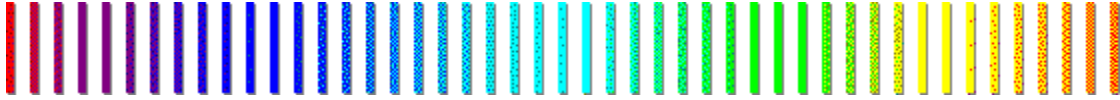

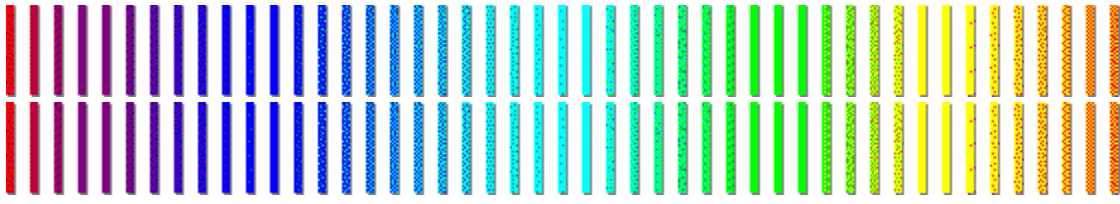

[Contents](#)

[Optimizing Printer Performance](#)

Updating the Printer Software

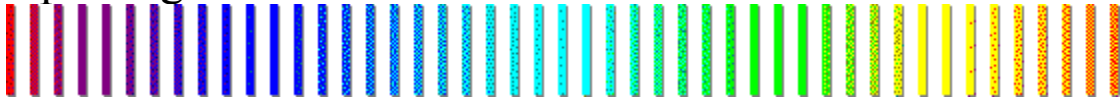

Hewlett-Packard periodically provides updates of the printer software. These updates may include enhancements that improve the performance of your printer.

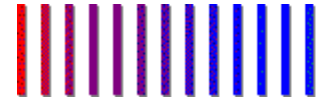

[Getting Help from HP](#)

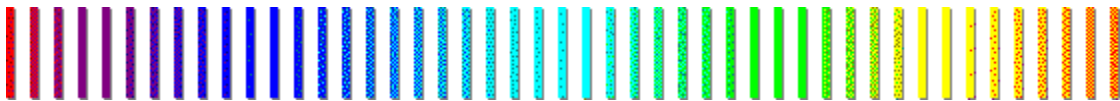

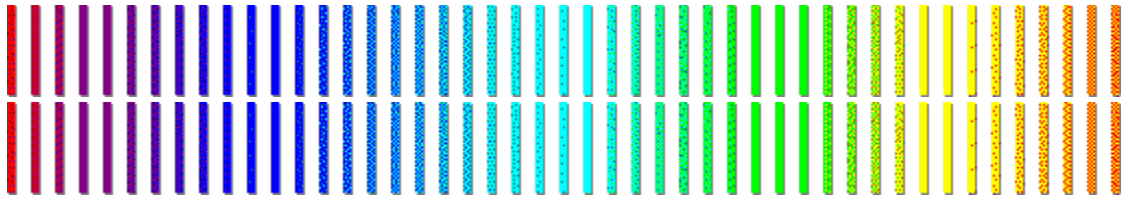

Optimizing Printer Performance

Using EconoFast

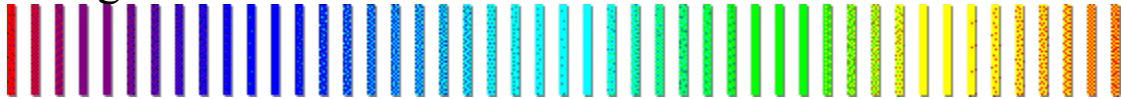

EconoFast mode provides draft-quality printing. EconoFast mode prints faster than both Normal mode and Best mode. Using EconoFast will also cut down on the frequency of replacing your print cartridges because it uses less ink.

EconoFast printing is available only when you select plain paper or transparencies as the paper type.

Note: For printing drafts of color documents, select the EconoFast option and then the Print in Grayscale check box. This prints your drafts faster, using grayscale instead of color.

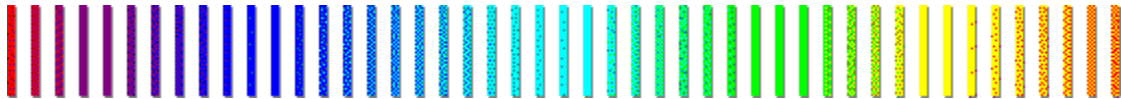

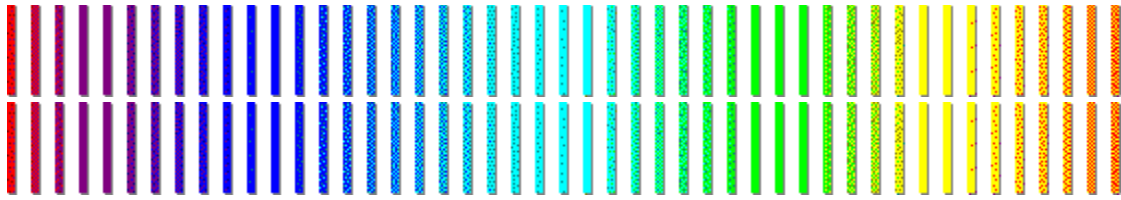

Optimizing Printer Performance

Automatic vs. Manual ColorSmart Options

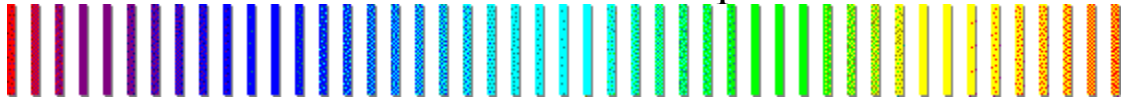

The Automatic and Manual options in the ColorSmart dialog box allow you to control the Halftoning, Intensity, and Color Control settings.

Automatic

This is the recommended setting for all documents.

The Automatic option uses ColorSmart technology to automatically select the best Halftoning, Intensity, and Color Control settings for both text and graphics.

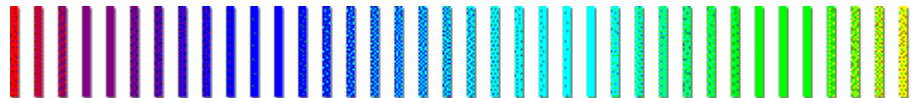

To let the printer automatically determine the ColorSmart settings

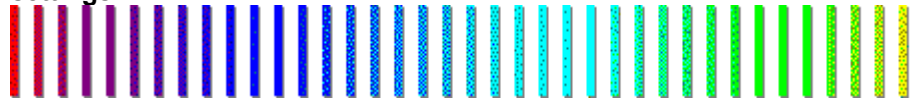

In the ColorSmart dialog box, select Automatic.

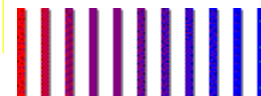

ColorSmart Dialog Box

Manual

Select this option to manually select the Halftoning, Intensity, and Color Control settings for both text and graphics.

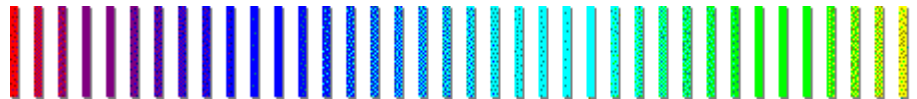

To manually control the ColorSmart settings

- 1 In the ColorSmart dialog box, select Manual.
- 2 Choose the Options button to display the ColorSmart Options dialog box.
- 3 To control the amount of ink used, move the Intensity slider to the left for lighter images (less ink), or to the right for darker images (more ink).
- 4 Under Halftoning, select either Pattern or Scatter.
- 5 Under Color Control, select either Vivid Color or Match Screen.

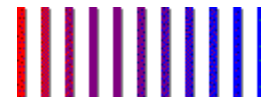

ColorSmart Options Dialog Box

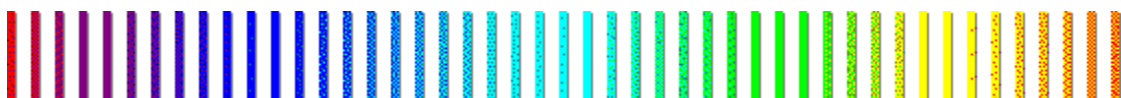

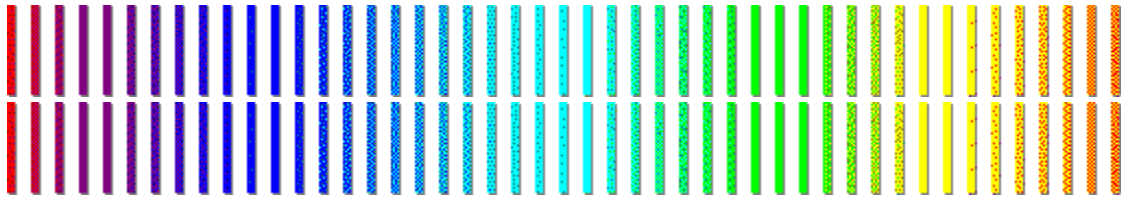

[Contents](#)

[Optimizing Printer Performance](#)

Color Printing vs. Black Printing (HP DeskJet 600 Only)

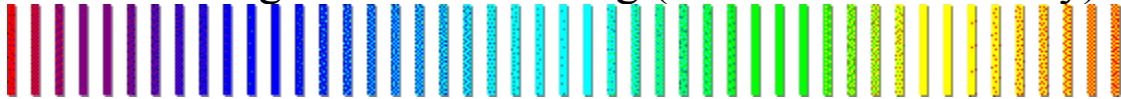

Your HP DeskJet 600 printer can print in color when a color printer driver and a color-capable software application are used with the printer. Other than installing the color print cartridge, no physical modifications to the printer are necessary.

To print in color, select color printing in your software application's print dialog box. If you are printing from a Windows-based application, you need to also select the HP DeskJet ColorSmart printer driver.

The quality of your color printing depends partly on how the four inks--black, cyan, yellow and magenta--are placed on the printed page. Your HP DeskJet 600 printer uses HP's ColorSmart technology to intelligently analyze your documents to produce the best color output.

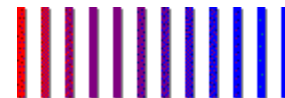

[ColorSmart Options
Dialog Box](#)



[HP ColorSmart Printer
Driver](#)

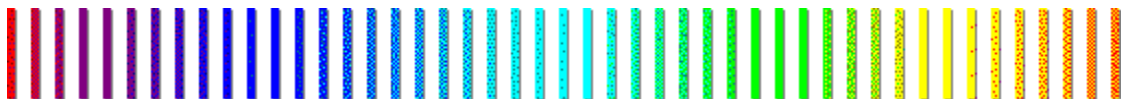

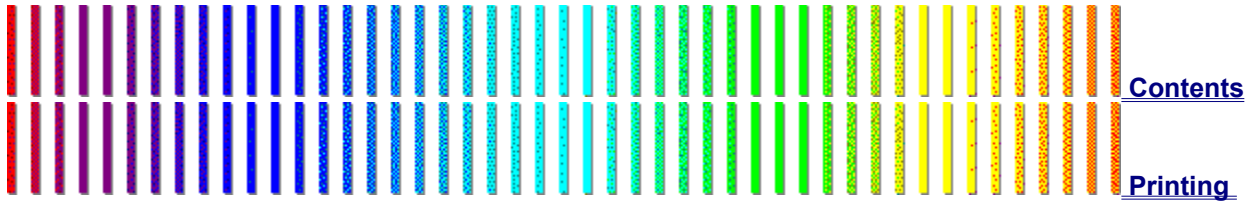

Tips

Printing Presentation Slides

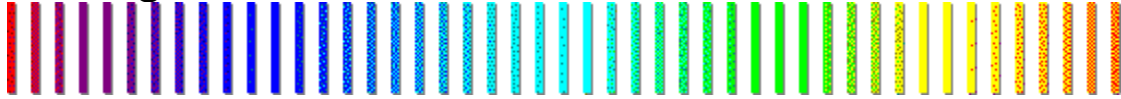

Overhead slides and transparencies may require special handling. The settings you select in the ColorSmart dialog box will affect the quality of your printouts.

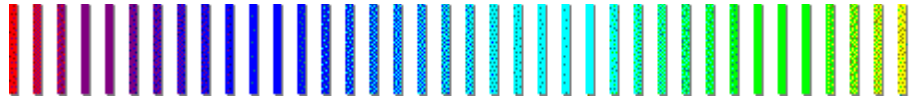

To print high-quality presentation slides

- 1 Insert HP Premium Transparency Film in the paper tray with the rough side down and the adhesive strip forward.

HP Premium Transparency Film is specially designed to work with your HP DeskJet printer.

- 2 In the ColorSmart dialog box, do the following:

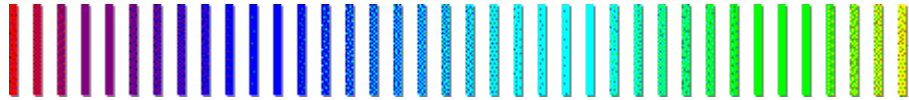

Select Automatic.

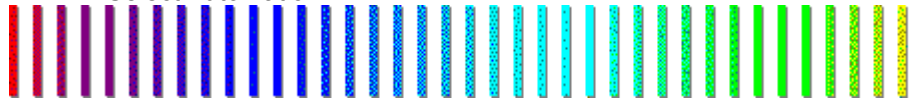

Under Print Quality, select Best.

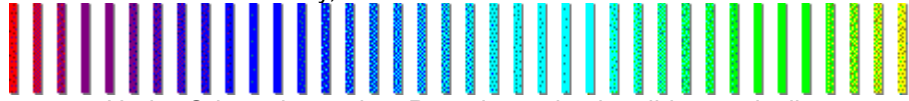

Under Orientation, select Portrait to print the slides vertically or select Landscape to print the slides horizontally.

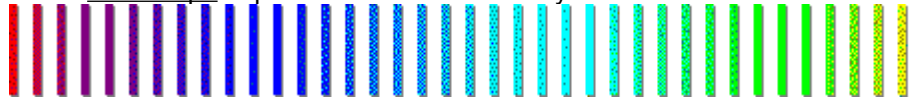

Type or select the number of copies you want to print.

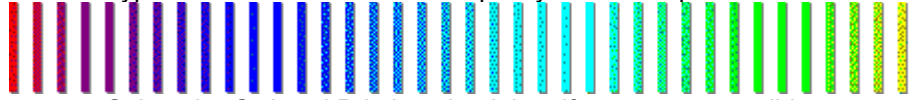

Select the Ordered Printing check box if you want your slides printed in the correct order. Clear the Ordered Printing check box if you want your slides printed in reverse order.

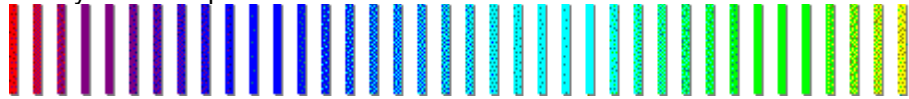

In the Paper Type pull-down list, select Transparency.

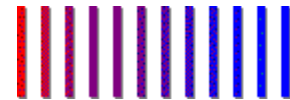

Installing Paper and Other Media

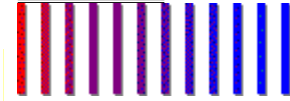

ColorSmart Dialog Box

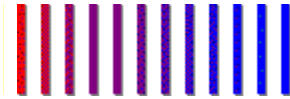

Printing on HP

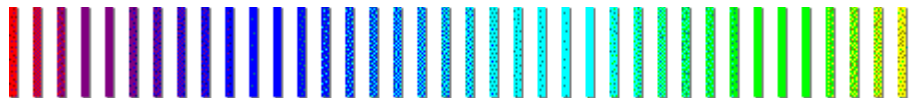

Premium Papers

In the Paper Size pull-down list, select Letter. (HP Premium Transparency Film is available only in letter size.)

3 Choose the OK button.

For optimal color print quality, wait 10 to 15 minutes after printing before you insert transparencies into protective sleeves. This gives them time to dry and prevents smearing and fading.

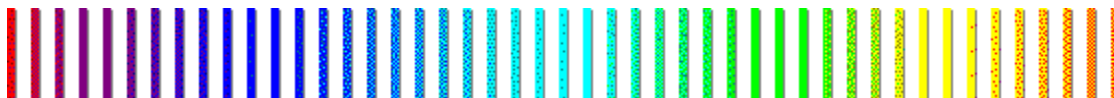

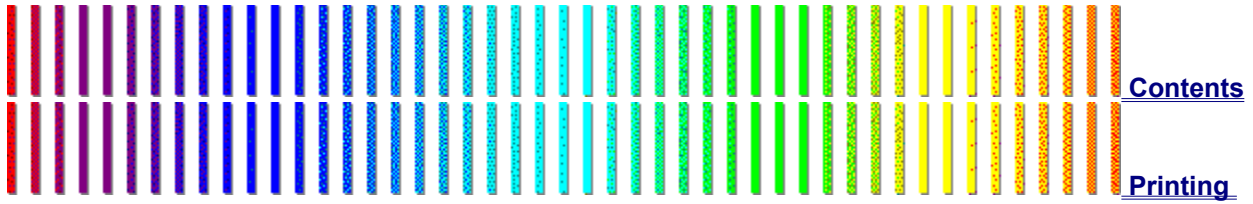

Tips

Printing on Envelopes

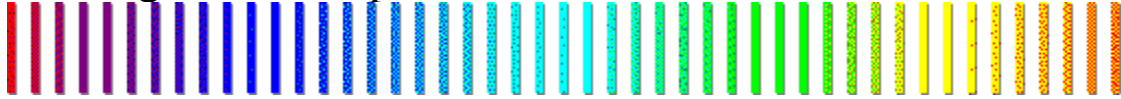

You can load up to 20 envelopes at a time in the IN tray or feed a single envelope through the printer (without first removing the paper from the IN tray) by using the Single Envelope Slot. When using the Single Envelope Slot, you can alternate between printing on envelopes and printing on paper. This feature is useful when you are printing a series of letters and their corresponding envelopes.

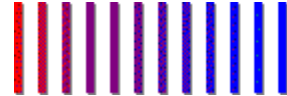

Printing on Custom Paper Sizes

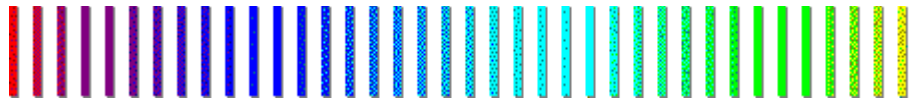

To load an envelope using the Single Envelope Slot

- 1 Slide either a No. 10- or a DL-size envelope through the Single Envelope Slot until it stops.

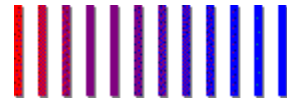
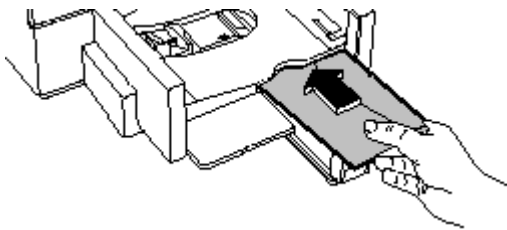

Installing Paper and Other Media

Make sure that the creased flap edge of the envelope aligns with the right side of the slot.

- 2 In the ColorSmart dialog box, set the Paper Type and Paper Size settings to the size of the envelope that is currently in the printer.

Be sure to reset the Paper Type and Paper Size settings from the paper in the IN tray after printing on the envelope.

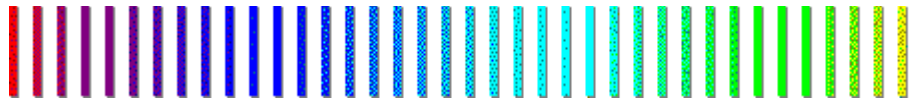

To load an envelope in the IN tray

- 1 Slide the paper-width adjuster to its leftmost position.

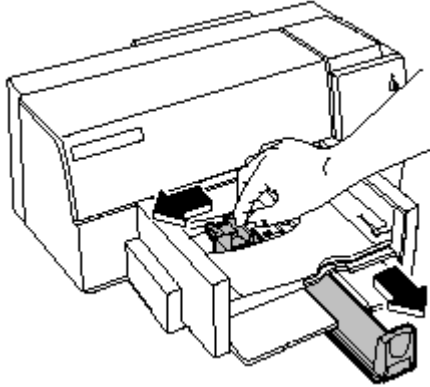

- 2 Pull out the paper-length adjuster and remove any paper from the IN tray.

Note: Make sure that the card guide (used when printing on index cards and postcards) is in the down position.

- 3 Remove up to 20 envelopes from their packaging and tap the short edge of the envelopes on a flat surface to even the stack.
- 4 Slide the envelopes evenly into the IN tray, with the address side down (flap side up).
- 5 Make sure that the creased flap edge of the stack aligns with the right side of the IN tray.
- 6 Slide the paper-width adjustment lever to the right until it aligns with the left edge of the envelope stack.

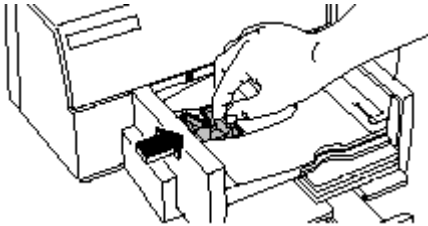

- 7 Push the paper tray extender in toward the envelopes until it stops. Make sure that the envelopes do not bend in the IN tray.
- 8 In the ColorSmart dialog box, set the Paper Type and Paper Size settings to the size of the envelope that is currently in the printer.

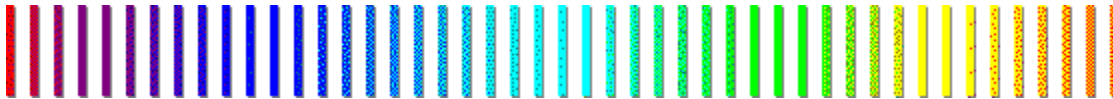

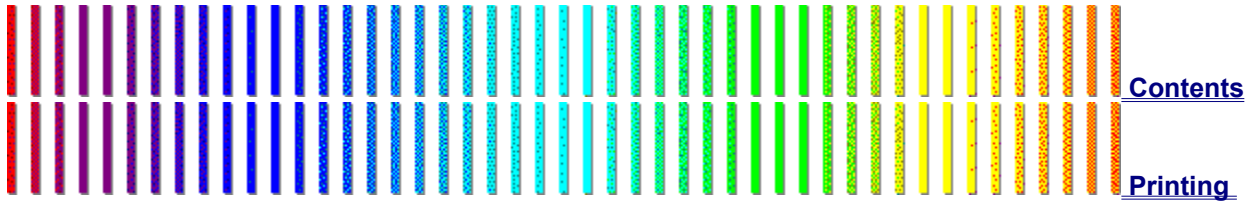

Tips

Printing on Custom Paper Sizes

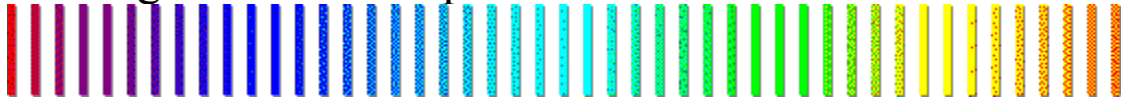

If the standard paper sizes supported by the printer do not match the paper size you want to use, you can use the Custom dialog box to define custom paper sizes. The paper width must be between 5 inches and 8.5 inches (127 mm to 215 mm); the length must be between 5.83 inches and 14 inches (148 mm to 356 mm).

Note: To obtain the best print quality and avoid getting paper jammed in the paper feed rollers, use the following recommended media weights:

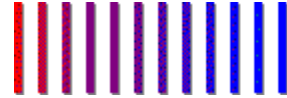

Installing Paper and Other Media

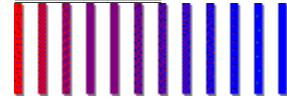

Printing Envelopes

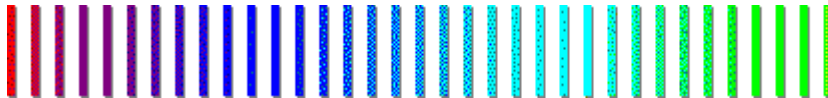

Paper - 16 to 35 lb.

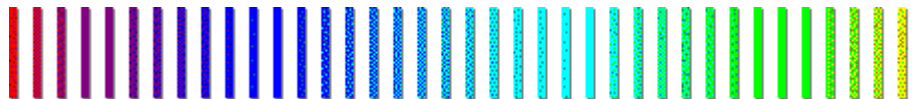

Envelopes - 20 to 24 lb.

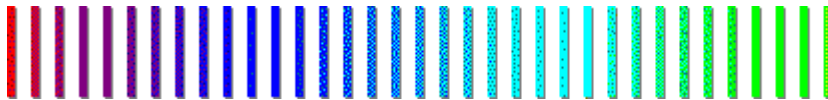

Cards - 110 lb.

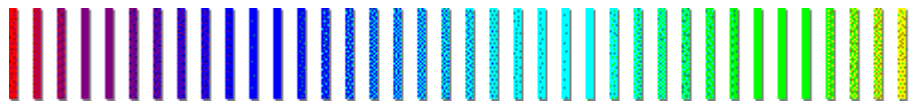

To print on custom paper sizes

- 1 In the ColorSmart dialog box, choose the Custom button.
The Custom Paper Size dialog box appears.
- 2 Make sure that the correct Units option is selected (English or Metric).
- 3 Type the width and length of your paper in the Width and Length fields under Paper Size.
- 4 Choose the OK button.

For more information about paper sizes, see your printer user's guide.

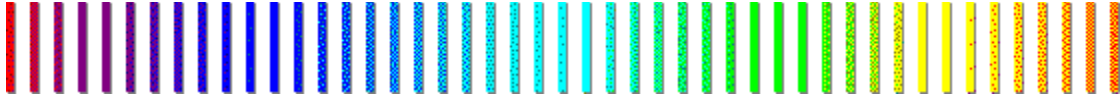

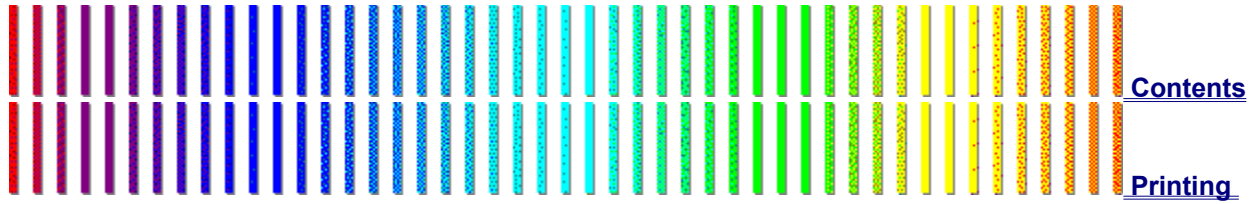

Tips

Printing on HP Premium Papers

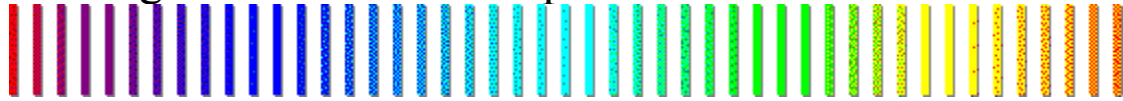

The purpose of your document and the quality you want will affect the paper or other media type you select for a print job. Make sure that the paper type selected in the ColorSmart dialog box matches the paper or other media loaded in the printer. The printer software adjusts the way it puts ink on a page for the selected media type. Using a media type different from the type selected in the ColorSmart dialog box will result in lower print quality.

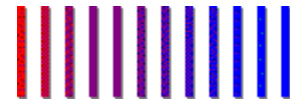

Installing Paper
and Other Media

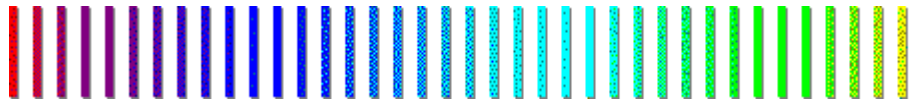

To select a paper type

- 1 In the ColorSmart dialog box, click the down arrow in the Paper Type list box to display the available paper types.

-or-

Press TAB to highlight the Paper Type list box, and then press ALT+DOWN ARROW to display the available paper types.

- 2 Click the paper type for your current print job.

-or-

Press the arrow keys to highlight the paper type for your current print job.

Plain Paper - for bond or photocopy paper and envelopes.

Transparency - for color and black printing on HP Premium Transparency Film. If you are printing more than one page, the printer waits several minutes between printing transparencies to allow time for the ink to dry.

Transparency (Pause Control) - in high humidity where ink on transparencies may dry slowly. The printer stops printing after each transparency. You may want to remove each transparency from the printer OUT tray before resuming the print job. Choose the OK button in the dialog box to resume printing.

HP Glossy Paper - for HP Premium Glossy Paper, designed to enhance color output. If you are printing more than one page, the printer waits several minutes between printing sheets to allow time for the ink to dry.

HP Glossy Paper (Pause Control) - in high humidity where ink on glossy pages may dry slowly. The printer stops printing after each

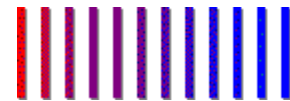

ColorSmart Dialog Box

sheet. You may want to remove each sheet from the printer OUT tray before resuming the print job. Choose the OK button in the dialog box to resume printing.

HP Premium InkJet Paper - designed to enhance black or color output.

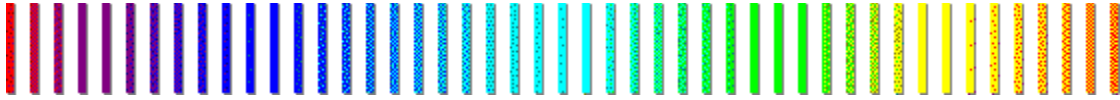

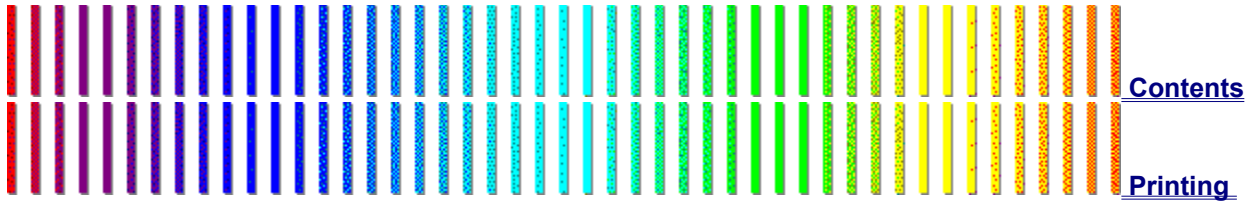

[Contents](#)

[Printing](#)

Tips

Printing in Grayscale

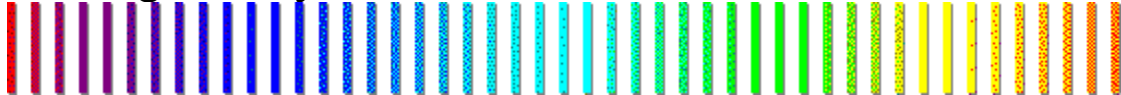

Save time and ink by printing draft copies of color documents in grayscale. With grayscale imaging, colors and saturation levels of color are represented as different shades of gray.

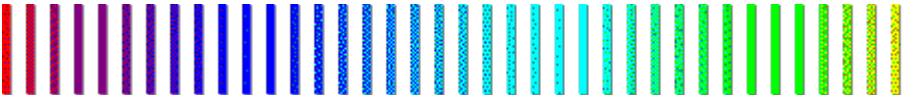

To print a document in grayscale

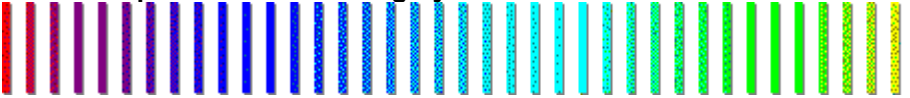

In the ColorSmart dialog box, select (check) the Print in Grayscale check box.

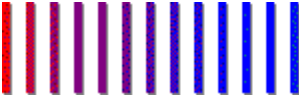

ColorSmart Dialog Box

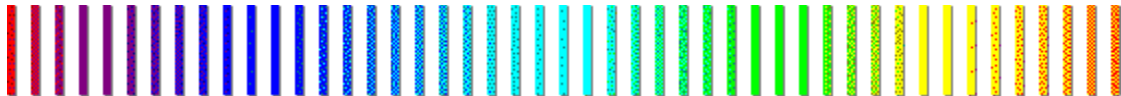

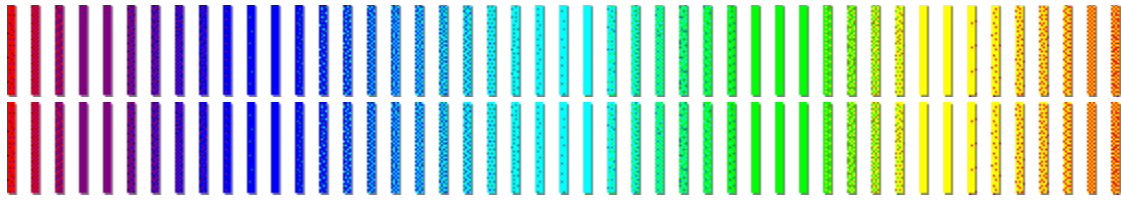

[Contents](#)

[Printing](#)

[Tips](#)

Using Color

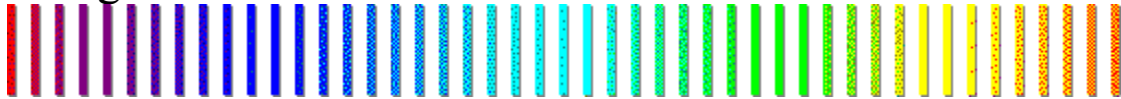

Color is a powerful tool when you are presenting information visually. Effective use of color can add emphasis and impact, create continuity and interest, and generally enhance the appearance and professionalism of your printed materials.

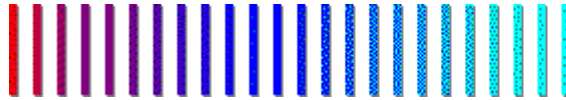

ColorSmart: What It Is and How It Works

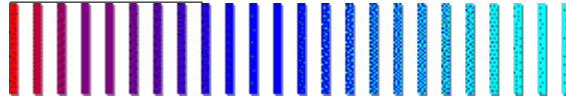

When and Where to Use Color

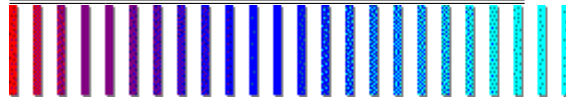

Choosing Color

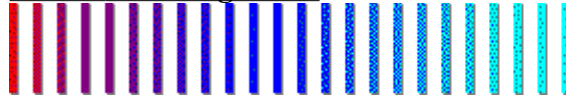

HP Color Kit (HP DeskJet 600 Printer Only)

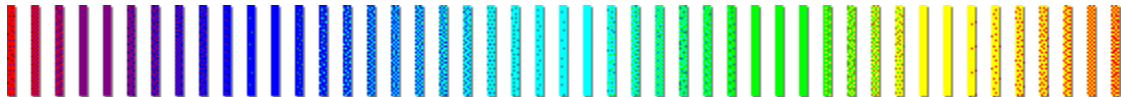

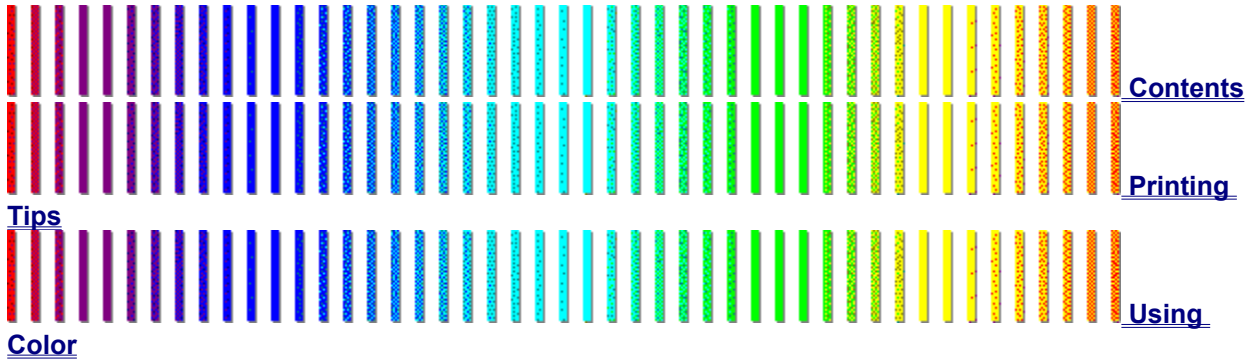

ColorSmart: What It Is and How It Works

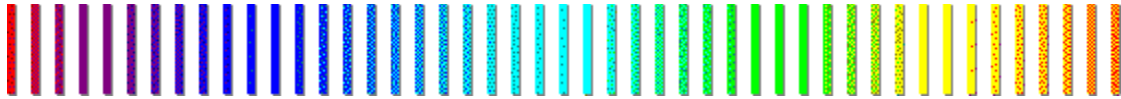

Hewlett-Packard's ColorSmart technology makes it easy to print high-quality color documents. ColorSmart analyzes each document and automatically selects color settings that produce the best quality printout every time you print.

The ColorSmart technology within the HP ColorSmart printer driver scans the document in memory as it is being sent from the computer to the printer. It looks for different types of objects, using logic to determine which portions of the page are text, colored headlines, simple graphics, scanned photographic images, and so forth. ColorSmart then searches the printer's library of color maps to select the best color map for each object.

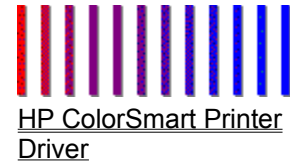

When you print color documents in grayscale, ColorSmart technology determines the best Halftoning and Intensity settings to represent colors as different shades of gray.

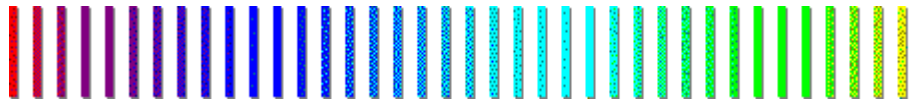

To use ColorSmart

In the ColorSmart dialog box, select Automatic. ColorSmart automatically selects the proper color settings for you document.

You can override the automatic ColorSmart settings at any time by selecting the Manual option in the ColorSmart dialog box.

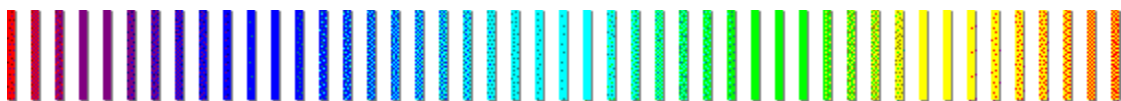
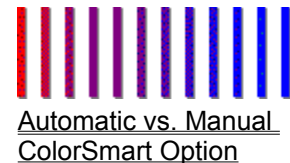
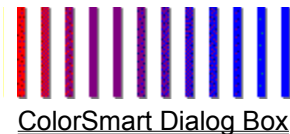

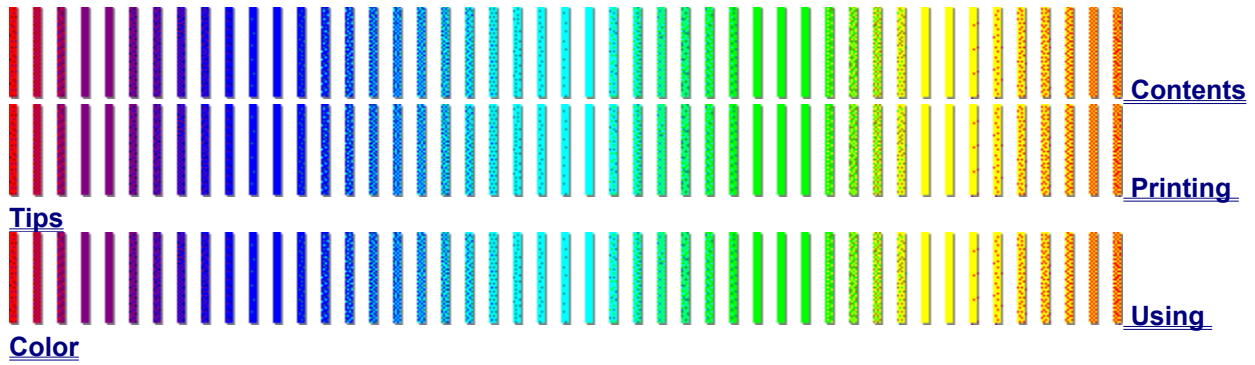

When and Where to Use Color

Used effectively, color can explain, highlight, and emphasize important information. Used incorrectly, color can distract the reader. Use these guidelines to help you enhance your printed materials with color.

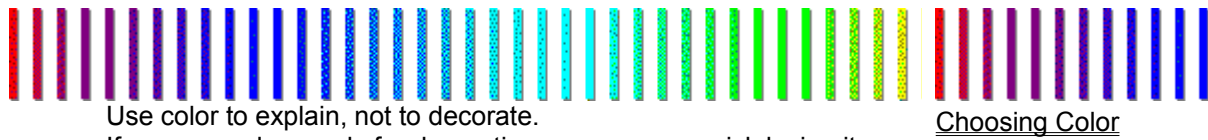

Use color to explain, not to decorate.
 If you use color purely for decorative purposes, you risk losing its effectiveness.
 Example: You can use color backgrounds instead of lines or boxes to define the parts of a form.

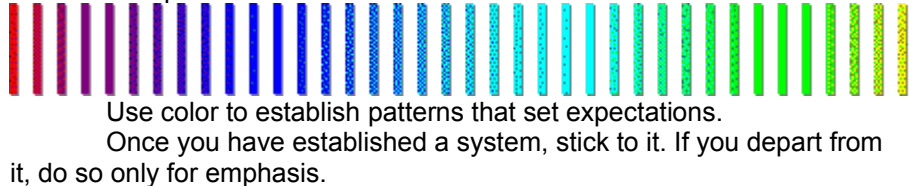

Use color to establish patterns that set expectations.
 Once you have established a system, stick to it. If you depart from it, do so only for emphasis.
 Example: In a spreadsheet, you can use one color to highlight subtotals and another color to highlight totals.

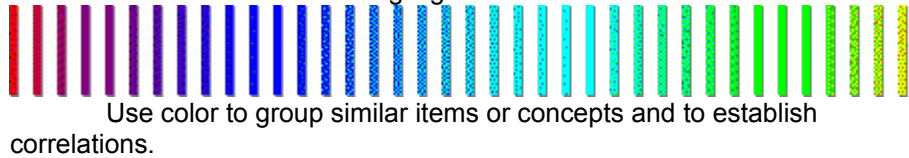

Use color to group similar items or concepts and to establish correlations.
 If you want to establish a relationship between color and meaning, use only a few carefully chosen colors.
 Example: In a presentation that covers three or four major topics, you can change the color of the heading when you make a transition to a new topic.

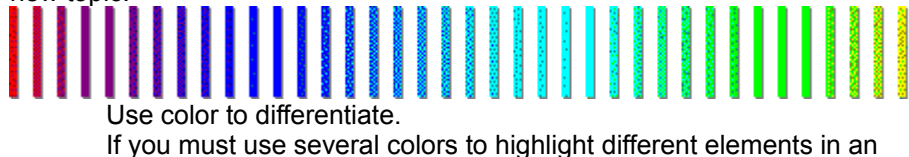

Use color to differentiate.
 If you must use several colors to highlight different elements in an image, enlarge the size of the image to improve legibility.
 Example: You can correlate the colors in a bar chart to the information that the different bars represent. Or, to highlight a particular

segment in a pie chart, use color only on that segment.

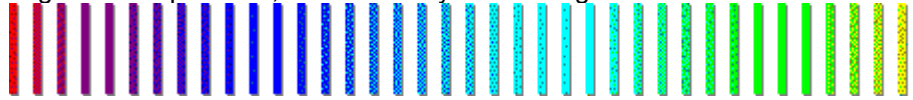

Use less color, not more.

By limiting your use of color, you maximize its impact.

Example: In a map, you can use color to call attention to the areas of interest rather than using color on the whole map.

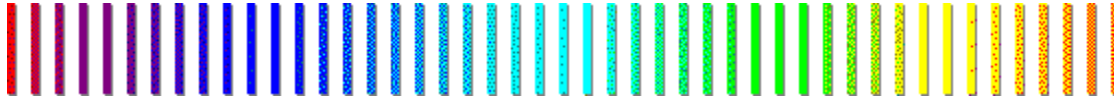

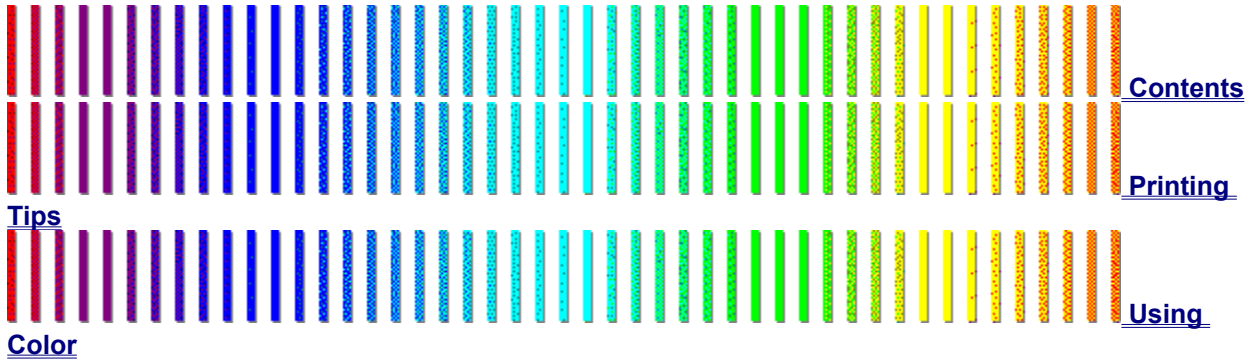

[Tips](#)

[Color](#)

Choosing Color

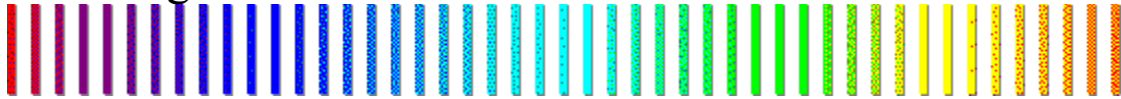

To select the appropriate colors for your print job, you need a basic understanding of color relationships. The color wheel (shown here) is a useful tool for identifying color combinations that work well together.

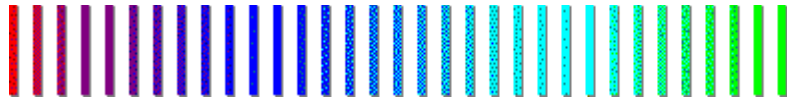
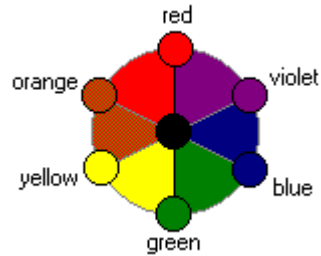

You can select one hue from the color wheel to unify your documents. To add visual interest, vary the lightness or darkness of the color you choose.

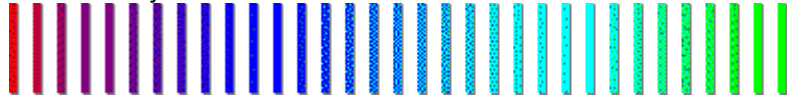

You can select two hues that are near each other on the color wheel to create harmony, such as blue and green. Colors that are close to each other on the color wheel are related.

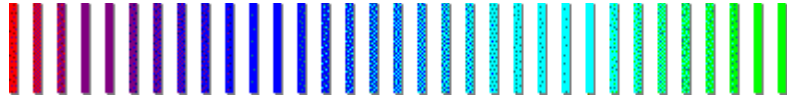

You can select hues with three colors between them on the color wheel to create contrast. For example, red and yellow, or green and violet. Use duller colors in the background and brighter colors in the foreground.

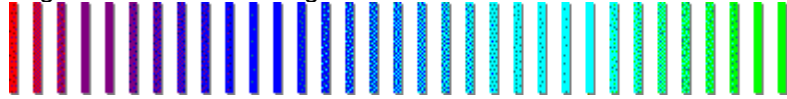

Using colors opposite each other on the wheel, such as red and green, is not recommended. However, you can change the saturation or value of one of these complementary colors to achieve better results.

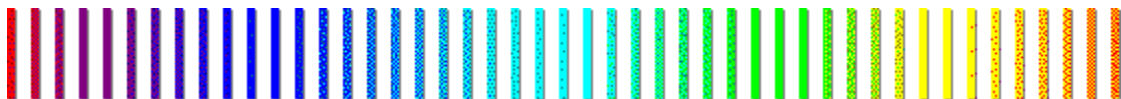

Hue

Color, or the gradation of color. Colors are named by hue: red, green, blue, and so forth.

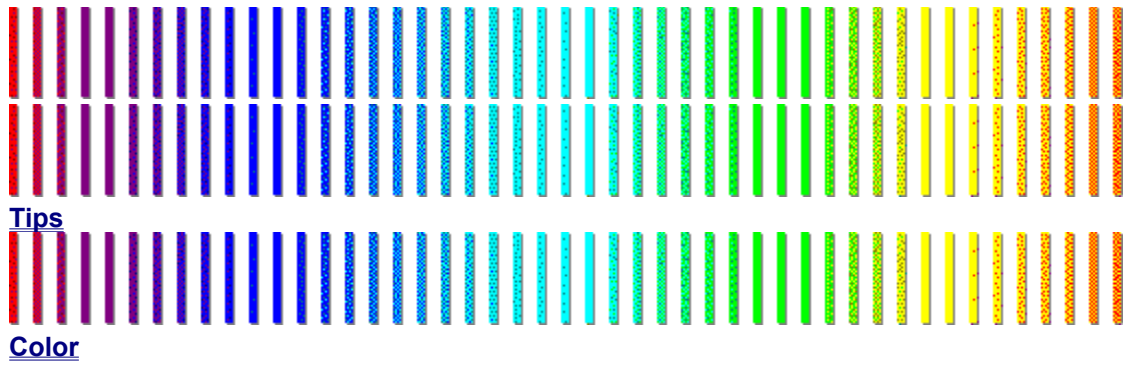

[Contents](#)

[Printing](#)

[Tips](#)

[Color](#)

[Using](#)

HP Color Kit (HP DeskJet 600 Printer Only)

You can print in color with the HP DeskJet 600 printer by using the optional HP Color Kit. The HP Color Kit includes color printing software and a color print cartridge.

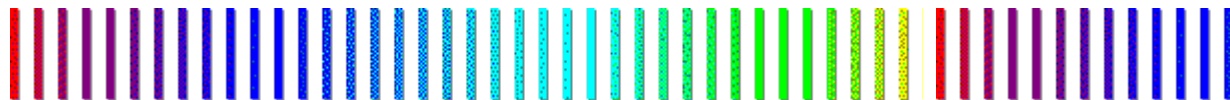

To print in color with the HP Color Kit

Installing Print Cartridges

Simply replace the black print cartridge with the color print cartridge that was supplied with the HP Color Kit.

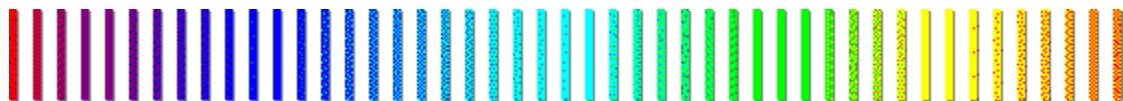

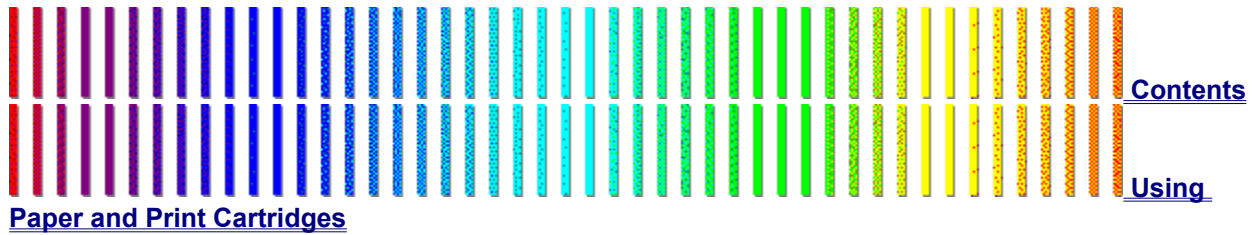

Installing Paper and Other Media

HP DeskJet 600 Series printers print on plain paper and other [media](#) types.

To add paper to the IN tray, remove all remaining paper from the IN tray and combine it with a new stack of the same paper. Tap the stack on a flat surface to even the stack. Never load more than 1/2 inch (1 cm) of paper or transparencies, 1/4 inch (1/2 cm) of cards, or 20 envelopes into the IN tray at one time.

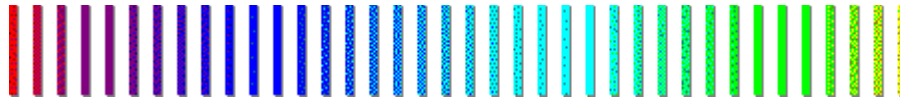

To load paper and other media

- 1 Slide the paper-width adjustment lever to its leftmost position.

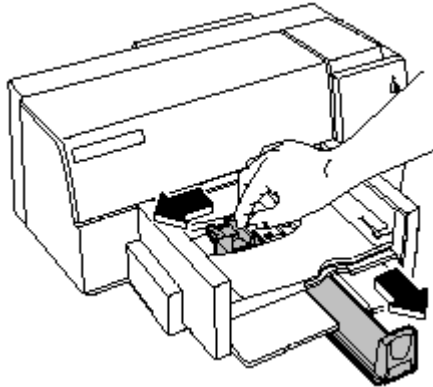

- 2 Pull out the paper tray extender.
- 3 Remove a 1 cm (approximately 1/2 inch) stack of paper from the package and tap the short edge of the stack on a flat surface to even the stack.

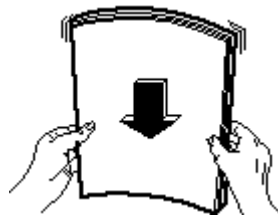

- 4 Insert the paper evenly into the IN tray, print side down, until it stops. Align the right edge of the stack with the right edge of the IN tray.
- 5 Push the paper tray extender in toward the printer, making sure that the paper does not bend in the IN tray.

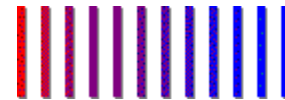

[Printing on Custom Paper Sizes](#)

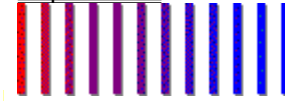

[Printing Envelopes](#)

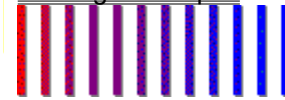

[Printing on HP Premium Papers](#)

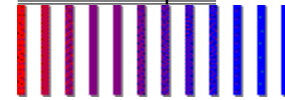

[Printing Presentation Slides](#)

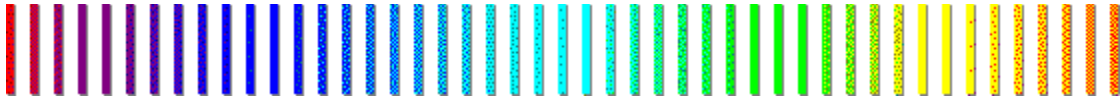

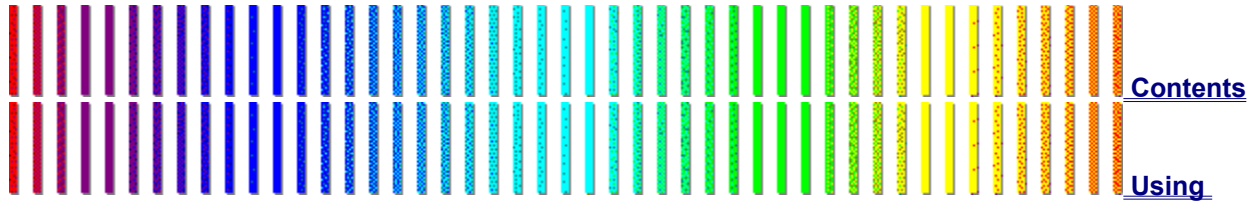

Paper and Print Cartridges

Installing Print Cartridges

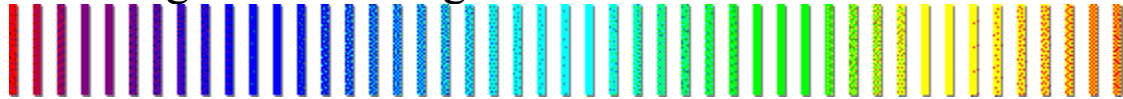

Most often, you will install a print cartridge when the one you are using is empty. For the HP DeskJet 600 printer, you will also change print cartridges when the document you are printing contains color images and the black print cartridge is installed, or vice versa.

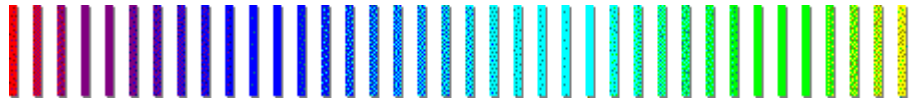

To remove a print cartridge

- 1 Make sure your printer is turned on.
- 2 Open the top cover of the printer.

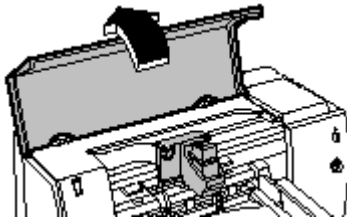

- 3 Grasp the top of the print cartridge and pull the cartridge top toward you until the cartridge pops loose.

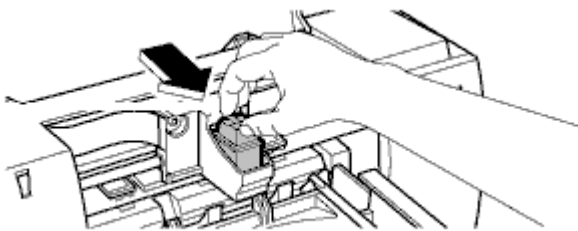

- 4 Lift the print cartridge out of the cradle.
- 5 Store the print cartridge in the print cartridge storage container to ensure that the print cartridge does not dry out or clog.
-or-
Discard the cartridge if it is empty.

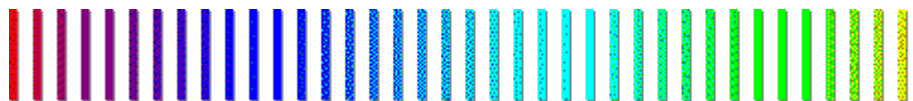

To install a new print cartridge

- 1 Make sure that your printer is turned on.

- 2 Open the top cover of the printer.
- 3 Grasp the print cartridge by the blue top and remove the cartridge from the package.
- 4 Gently remove both pieces of tape covering the ink nozzles on the print cartridge.

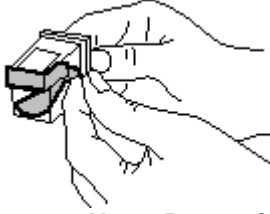

Note: Be careful not to touch the ink nozzles or the copper contacts.

- 5 Place the print cartridge in the cradle so that the blue arrow on the cartridge top points to the top of the cradle.
- 6 Push the blue arrow toward the top of the cradle until the cartridge snaps into place.

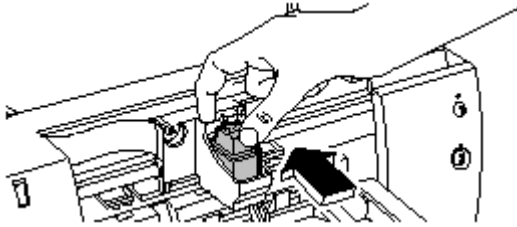

- 7 Close the top cover of the printer. The print cartridge cradle will move to the right side of the printer (the "home" position).

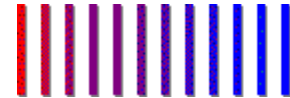

Aligning Print Cartridges

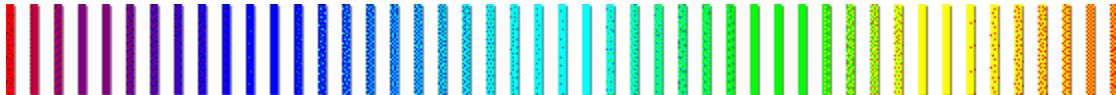

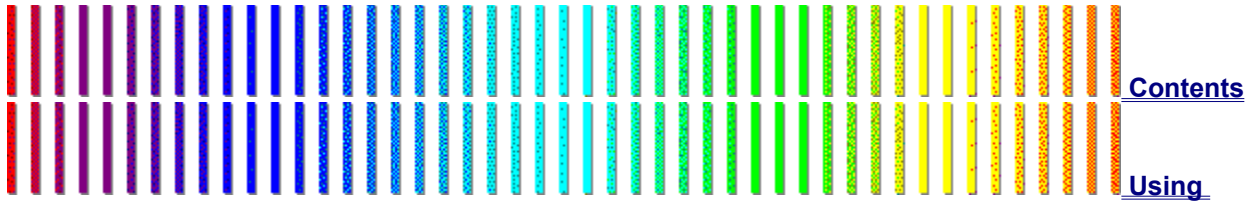

Paper and Print Cartridges

Aligning Print Cartridges

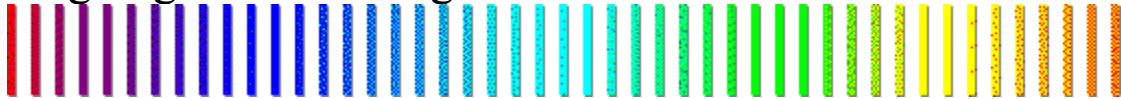

Align the black and color print cartridges each time you replace or install a print cartridge. This will ensure that the black and color inks are aligned when used together on the same line of text or within the same graphic. Alignment of the print cartridges reduces any mixing of the color inks with the black ink and it reduces spaces between black and color inks.

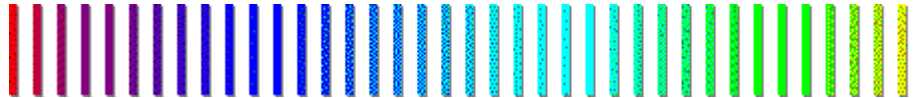

To align the print cartridges

- 1 Make sure that the printer is on and the power light  is lit.
- 2 Double-click the HP DeskJet Status Monitor icon in the HP DeskJet Utilities program group.
- 3 From the Maintenance menu, choose Align Print Cartridge.
A page will print that contains two sets of alignment patterns.
- 4 Follow the instructions on the screen to properly align your print cartridges.

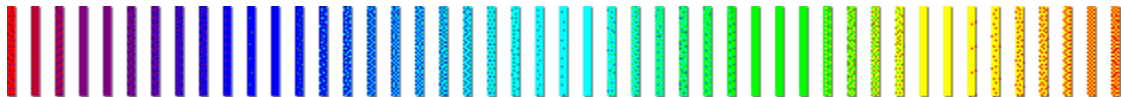

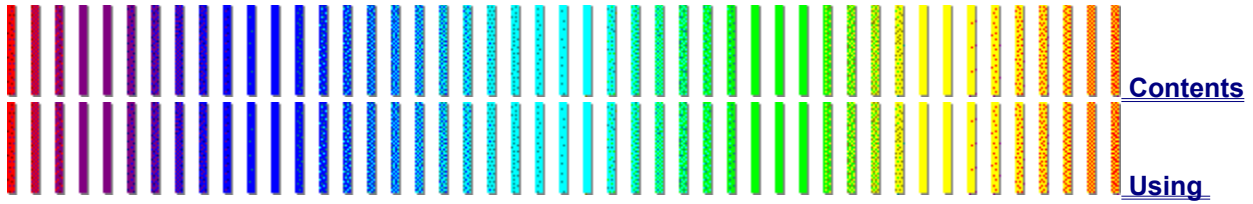

[Contents](#)

[Using](#)

[Paper and Print Cartridges](#)

Cleaning Print Cartridges

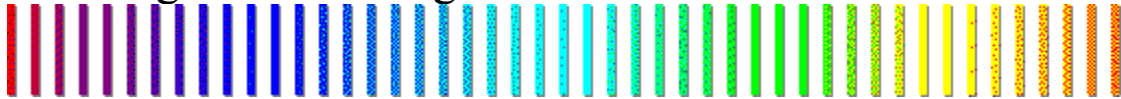

Clean the print cartridges when you notice that lines or dots are missing from your printed text and graphics. The print cartridges can be cleaned by using the HP Status Monitor from within Windows or by using the buttons on the front of the printer.

Note: Do not clean the print cartridges unnecessarily, because this wastes ink and shortens the life of the print cartridge.

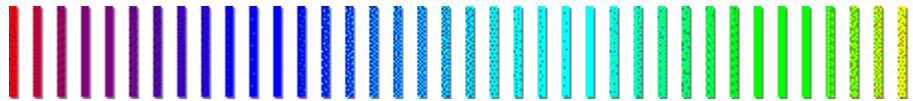

To clean a print cartridge from the HP DeskJet Status Monitor

- 1 Double-click the HP DeskJet Status Monitor icon in the HP DeskJet Utilities program group.

The HP DeskJet Status Monitor appears.

- 2 From the Maintenance menu, choose Clean Print Cartridge.
- 3 In the dialog box that appears, choose the Clean button.

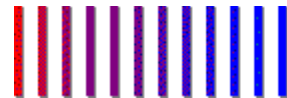

A page will print that shows how well the cleaning process worked. Follow the instructions on your screen to complete the cleaning procedure.

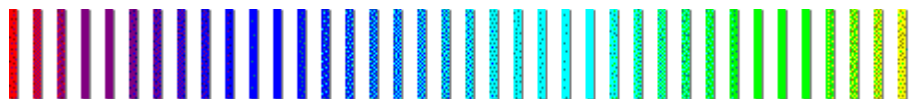

[About the HP DeskJet Status Monitor](#)



To clean a print cartridge by using the printer buttons

- 1 With the printer turned on, press and hold down the power  button.
- 2 While still holding down the power  button, press and release the resume  button seven times.
- 3 Release the power

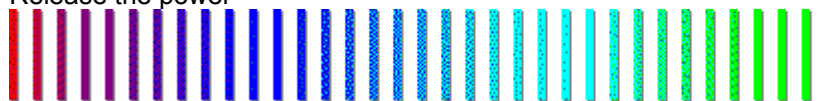

button.

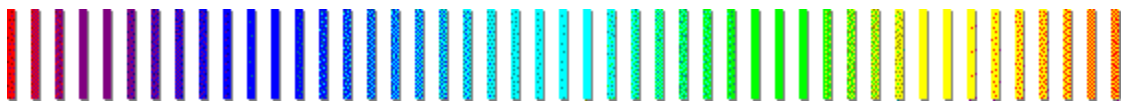

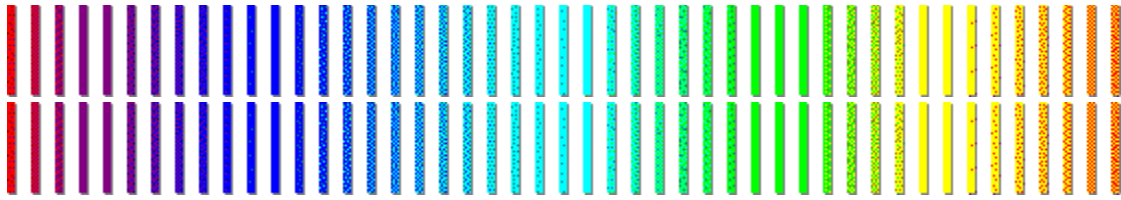

[Contents](#)

[If You](#)

[Have a Printing Problem](#)

Doing a Performance Checkup

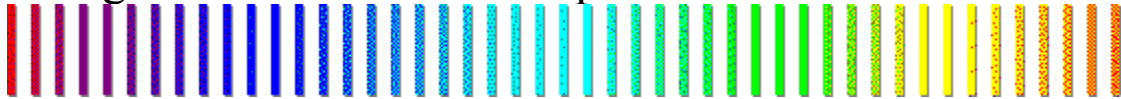

Each of the following maintenance checks will verify or refresh the printing system's ideal performance levels.

Printer self-test

Perform a self-test to verify that the printer is working properly and that the cable connection is at least at minimum standards.

Print cartridge cleaning

Perform a print cartridge cleaning when print quality has noticeably decreased or when HP Help messages have recommended doing so.

Print cartridge alignment

Perform a print cartridge alignment whenever you have replaced or reinstalled a print cartridge or when other HP Help messages have recommended doing so.

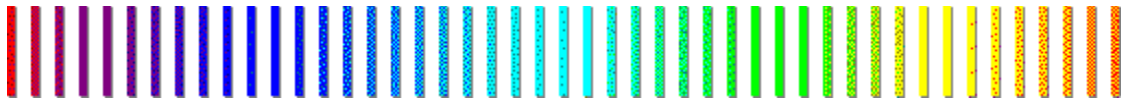

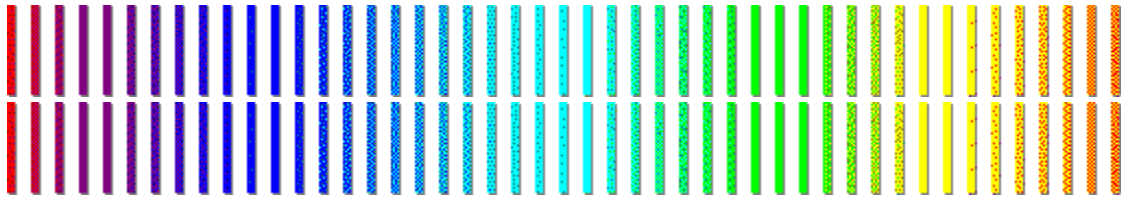

[Contents](#)

[If You](#)

[Have a Printing Problem](#)

Checking Printer Buttons and Lights

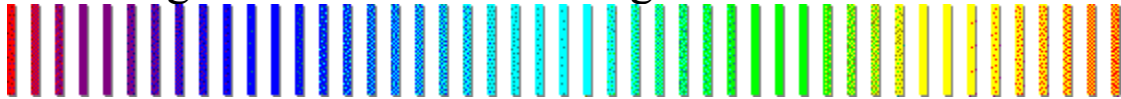

The buttons and lights on your HP DeskJet 600 Series printer give you information about your printer. When the printer is in the ready-to-print state, the power

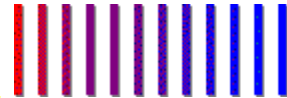

[Printer Buttons and Lights](#)

light is on and the resume

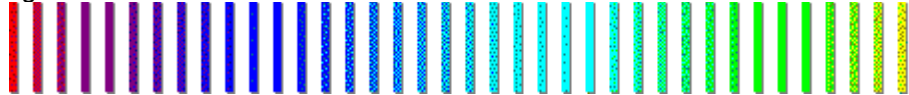

light is off. When the computer is sending a file to the printer and when the printer is printing a file, the power

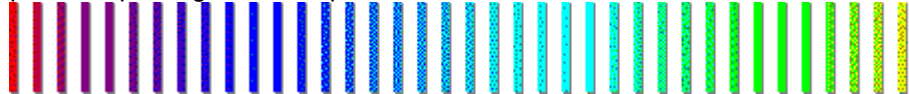

light blinks and the resume

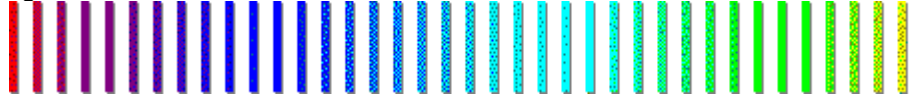

light is off. When the printer needs attention or when a printer error occurs, either the resume

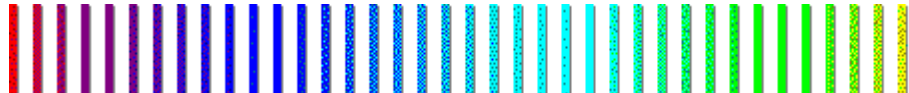

light blinks, or both lights blink alternately.

If paper, envelopes, cards, or transparencies are loaded in the printer and if the printer does not print, observe the state of the printer's power

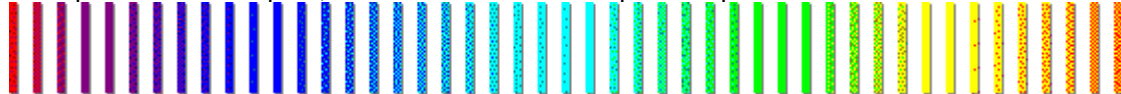

and resume

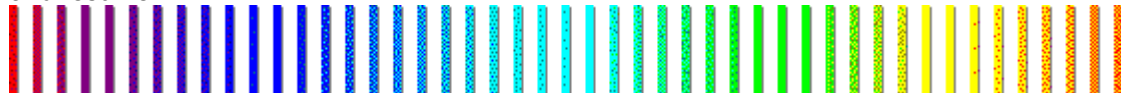

lights. If the power

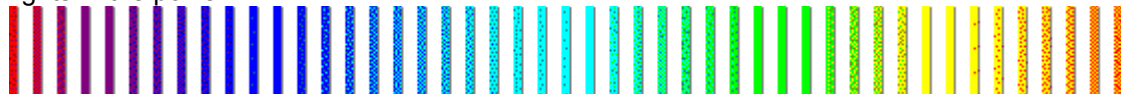

light is not on, press the power

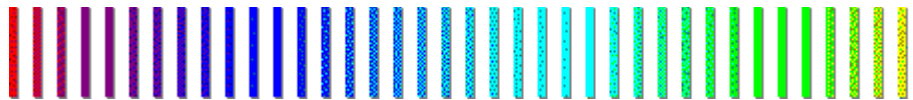

button to turn on the printer.

If the printer still fails to print, refer to the troubleshooting section of your printer user's guide for descriptions of various error conditions.

Also see whether Dr. DeskJet can help solve your printing problem.

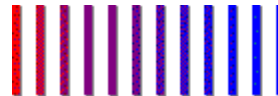

[Go to Dr. DeskJet](#)

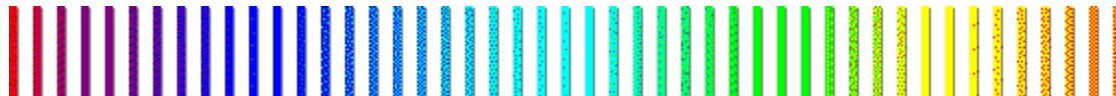

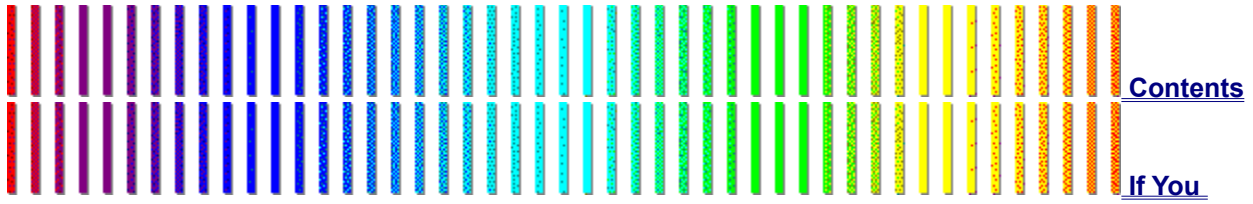

[Have a Printing Problem](#)

[Contents](#)

[If You](#)

Getting Help from HP



If problems occur when using your printer, see the troubleshooting section of your printer user's guide, or see the [Dr. DeskJet](#) topic in this online Help file. If you cannot find the solution to your problem, Hewlett-Packard provides a number of services to help you solve problems or to answer any questions you may have about your printer.

The available services vary from country to country and from region to region. For detailed information about services available in your country and region, refer to your printer user's guide.

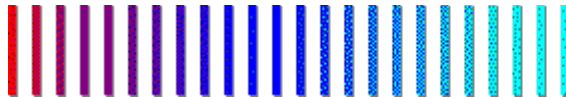

In the United States and Canada

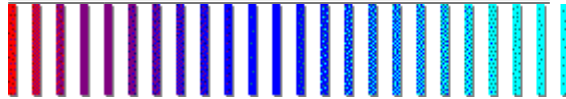

In Europe

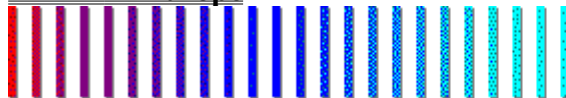

In Australia and New Zealand

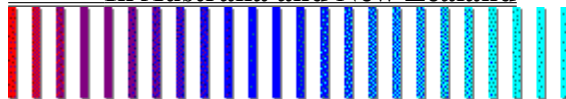

Elsewhere in the World

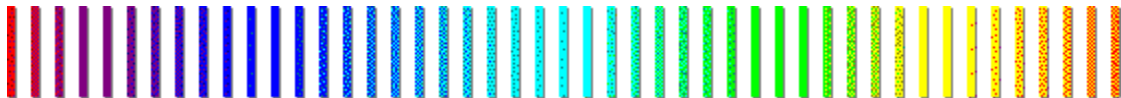

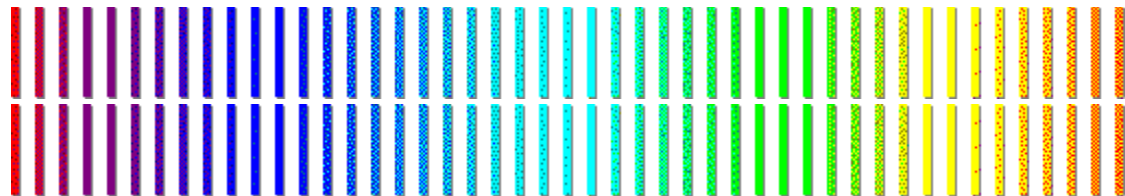

| | |
|---|--------------------------|
| Have a Printing Problem | Contents |
| Help from HP | If You |
| | Getting |

In the United States and Canada

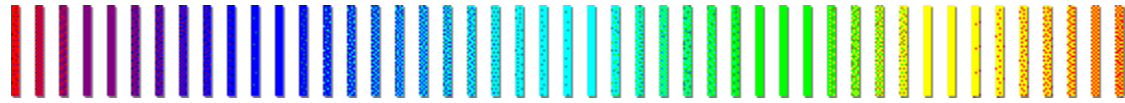

In the United States and Canada, there are many ways that you can obtain assistance from Hewlett-Packard for your HP DeskJet 600 Series printer:

24-Hour Support Information

Phone (800) 333-1917 to access HP Audio Tips or HP FIRST Fax, HP's 24-hour automated support services.

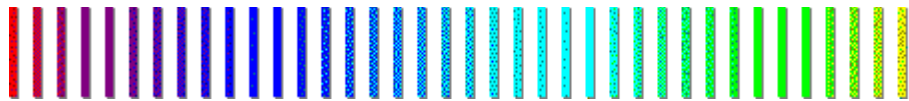

HP Audio Tips provides prerecorded help messages on common questions, as well as information on other resources within HP to get you the help you need. Selected messages can be faxed to you for future reference.

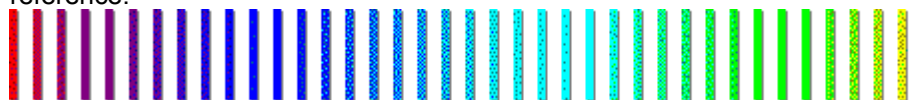

HP FIRST Fax will deliver detailed support information on common software programs and troubleshooting tips for your printer. You can access this service from any touch tone phone and request up to three documents per call. These documents will be sent to the fax of your choice within minutes.

Electronic Information Services

For 24-hour access to information over your modem:

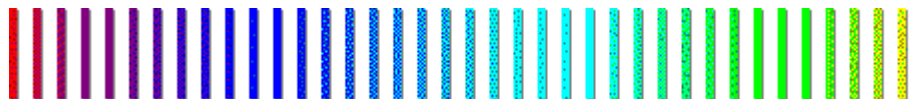

HP Download Service - HP's electronic download service is available 7 days a week, 24 hours a day for your convenient access to HP printer drivers, product information, and troubleshooting hints. Call (208) 344-1691. Set your communications software to N,8,1.

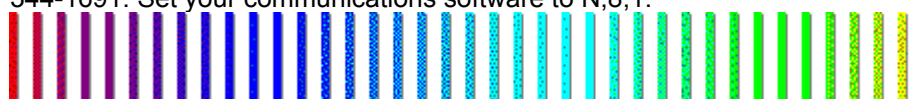

CompuServe - Printer drivers and interactive sharing of technical information are available on CompuServe's HP Peripherals forum (GO HPPER.) To subscribe, call CompuServe, INC, at (800) 524-3388 and ask for representative #51. (This service is not operated by Hewlett-Packard.)

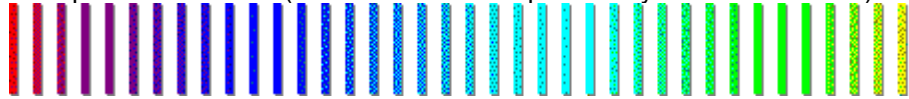

Internet - Printer drivers and product and support information can be obtained via HP's anonymous FTP site at 192.6.71.2 or ftp-boi.external.hp.com, which is available to anyone with FTP access to the Internet. Access through the World-Wide Web is at: URL <http://www.hp.com/home.html>.

HP Customer Support Center

During Warranty (208) 323-2551

Our highly responsive support staff is dedicated to helping you get your new product up and running. Our support staff is available Monday through Friday, from 7 am to 6 pm MST (except Wednesday - 7 am to 4 pm MST.) This service is available to you at no charge during the warranty of your printer. Please have your serial number ready when you call.

Post Warranty

Post-warranty telephone assistance is available to answer your product questions and to offer insight on how to use your product with the most commonly used software applications. We want to help you get the right information the first time you call. This service is available Monday through Friday, 7 am to 6 pm MST (except Wednesday - 7 am to 4 pm MST.) Call (900) 555-1500 (\$2.50 per minute, U.S.A. only). Charges begin only when you connect with a support technician. Or call (800) 999-1148 (\$25 per call; VISA or Master Card). Prices are subject to change without notice.

Hardware Repair Services

To speak with someone for technical assistance or repair information, call (208) 323-2551. This service is free during the warranty of your printer; however, you will be charged a toll for the phone call.

Updated Printer Drivers by Mail

HP's Distribution Center provides printer drivers and printer driver updates. You can order by calling (303) 339-7009, Monday through Saturday, 24 hours a day.

HP's Support Pack

Your 3-year protection plan in a box is available on your local reseller's shelves. Simply fill out the form included in the SupportPack box and mail it to HP. Once you have done this, your protection plan is in motion. HP helps you avoid down-time and lost productivity by providing fast and convenient next-day express replacement for your HP DeskJet 600 printer by our skilled service technicians. Purchase SupportPack from your local reseller.

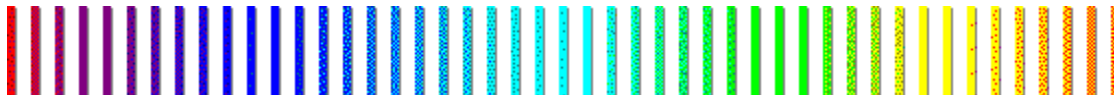

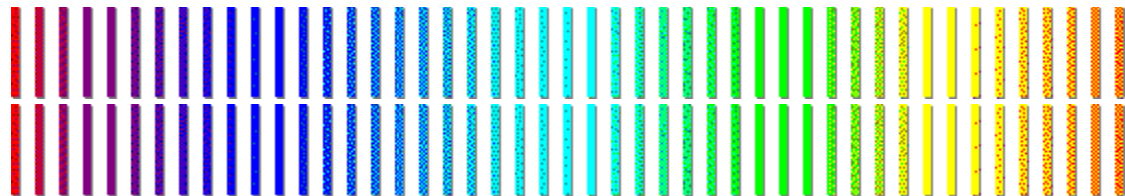

| | |
|--|---------------------------------|
| | <u>Contents</u> |
| | <u>If You</u> |
| <u>Have a Printing Problem</u> | |
| | <u>Getting</u> |
| <u>Help from HP</u> | |

In Europe

In Europe, there are many ways that you can obtain assistance from Hewlett-Packard for your HP DeskJet 600 Series printer:

Customer Telephone Support

If your printer is not operating properly, use these instructions to obtain help:

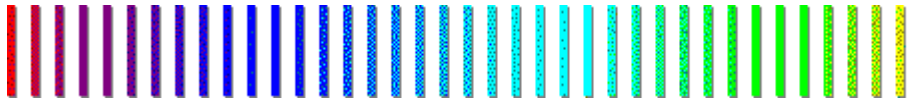

See the Troubleshooting and Maintenance chapter in your user's guide for suggestions to solve the problem or obtain information by fax through HP FIRST. See "Support Information by FAX" below.

For customers in the U.K., France, Germany, Switzerland, Austria, Belgium, Norway, Sweden, Denmark, Finland, Italy, Spain, and the Netherlands:

Use the suggestions listed above or contact the HP European Customer Support Center. This phone service is available at no charge during the printer warranty period. Phone numbers are given in a document shipped with the printer. For more information, call your dealer or nearest HP Sales and Support Office.

Customer support representatives can answer your questions regarding the setup, configuration, installation, and operation of your printer. They can also help troubleshoot and diagnose printer problems and give instructions for service and repair.

If you are unable to determine the cause of the failure, contact your local dealer or nearest HP Sales and Support Office for information on service and repair.

24 Hour Support Information by FAX

HP FIRST (FAX Information Retrieval Support Technology) is a no-charge, 24-hour self-help service that provides answers to the most common questions about your printer. Through HP FIRST, you can receive ordering information, software application notes, and printer driver update request

forms.

Simply dial the HP FIRST number from a touch tone phone or Group 3 facsimile machine and follow the voice prompts that guide you to select an index of available support and product documents.

| Country | Language | Toll Free Telephone Number |
|-----------------------------------|-----------------|-----------------------------------|
| Europe (outside Great Britain) | English | +31 20 681 5792 |
| Great Britain | English | 0800-96 02 71 |
| Austria | German | 0660-8128* |
| Belgium | Dutch | 0800 1 1906 |
| Belgium | French | 0800 1 7043 |
| Switzerland | German | 155-1527 |
| Switzerland | French | 155-1526 |
| Germany | German | 0130-810061 |
| Denmark | Danish | 800-10453 |
| Spain | Spanish | 900-993123 |
| France | French | 05-905900 |
| Italy | Italian | 1678-59020 |
| Norway | Norwegian | 800-11319* |
| Netherlands | Dutch | 06-0222420 |
| Sweden | Swedish | 020-795743* |
| Finland | Finnish | 9800-13134* |

*Local toll costs are charged

Electronic Information Services

For 24-hour access to information over your modem:

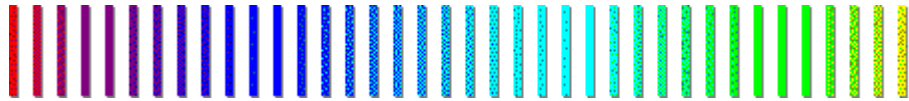

CompuServe - Printer drivers and interactive sharing of technical information are available on CompuServe's HP Peripherals forum (GO HOPPER). To subscribe to CompuServe, check your local phone directory for the nearest CompuServe location. (This service is not operated by Hewlett-Packard.)

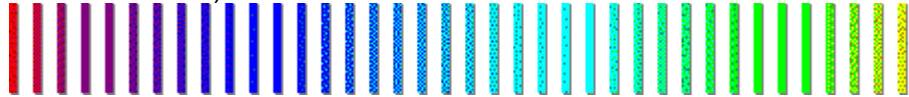

Internet - Printer drivers, product, and support information can be obtained via HP's anonymous FTP site at 192.6.71.2 or ftp-boi.external.hp.com; this is available to anyone with FTP access to the Internet. Access through the World-Wide Web is at: URL <http://www.hp.com/home.html>.

Printer Drivers by Mail

HP's Distribution Center provides printer drivers and printer driver updates by mail. To order updates to printer drivers, write to:

European Fulfillment for Hewlett-Packard
P.O. Box 63
Harlepool
Cleveland
TS25 2YP
United Kingdom

or phone:

English +44 (0) 429 865 511
French +44 (0) 429 863 343
German +44 (0) 429-863 353

HP's Distribution Center's business hours are Monday through Friday, 8:30 am to 6 pm CET (except Wednesday - 8:30 am to 4 pm CET).

Telephone Assistance - During Warranty

Our highly responsive support staff is dedicated to helping you get your new product up and running. Our support staff is available Monday through Friday, 8:30 am to 6 pm CET (except Wednesday - 8:30 am to 4 pm CET). This service is free during the warranty of your product; however, you are charged a toll for the phone call. Please have your serial number ready when calling. Phone numbers are given in a document shipped with your printer.

Hardware Repair Services

To speak with someone for technical assistance or repair information, contact the HP European Customer Support Center. Phone numbers are given in a document shipped with your printer. This service is free during the warranty of your printer; however, you will be charged a toll for the phone call.

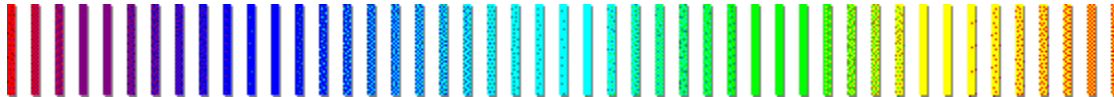

| | |
|---|--------------------------|
| Have a Printing Problem | Contents |
| Help from HP | If You |
| | Getting |

In Australia and New Zealand

In Australia and New Zealand, there are many ways that you can obtain assistance from Hewlett-Packard for your HP DeskJet 600 Series printer:

24-Hour Support Information

Call (03) 272-2627 in Australia or (09) 356-6642 in New Zealand to access HP FIRST Fax, HP's 24-hour automated support services. HP FIRST Fax will deliver detailed support information on common software programs and troubleshooting tips for your printer. You can access this service from any touch-tone phone and request up to five documents per call. These documents will be sent to the fax of your choice within minutes.

Electronic Information Services

For 24-hour access to information over your modem, call the **HP Download Service**. This electronic download service is available 7 days a week, 24 hours a day for your convenient access to HP printer drivers, product information and troubleshooting hints. Call (03) 890-0276 in Australia, or (09) 356 3684 in New Zealand.

HP Customer Support Center

To speak with someone for online technical assistance, call (03) 272-8000 in Australia, or (09) 356 6640 in New Zealand. This service is free for 12 months from the date of original purchase; however, you will be charged for the call. For technical assistance after the free period, a \$25 flat fee per single incident will apply.

Hardware Repair Services

To speak with someone for technical assistance or repair information, call 131147 in Australia or 0800-733-547 in New Zealand. This service is free during the warranty of your printer. Post-warranty repairs will be charged on a time and materials basis.

Refer Back to Your Dealer or Reseller

In most cases, your reseller should be able to provide assistance.

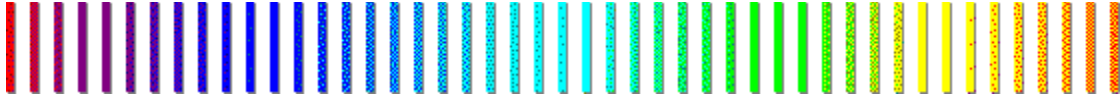

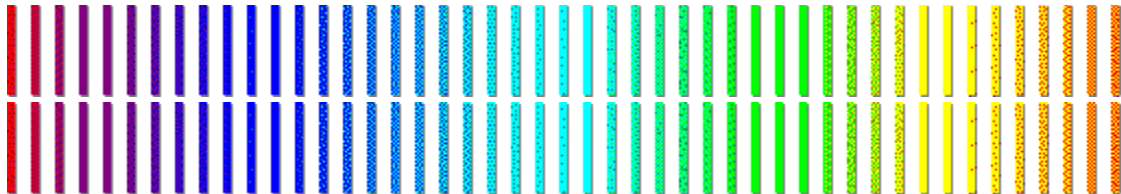

[Contents](#)

[If You](#)

[Have a Printing Problem](#)

[Help from HP](#)

[Getting](#)

Elsewhere in the World

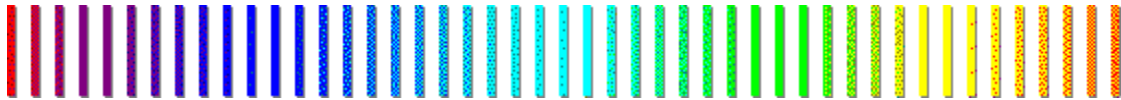

If your printer fails during or after the warranty period:

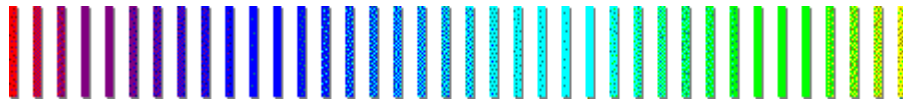

see the Troubleshooting section in your printer user's guide

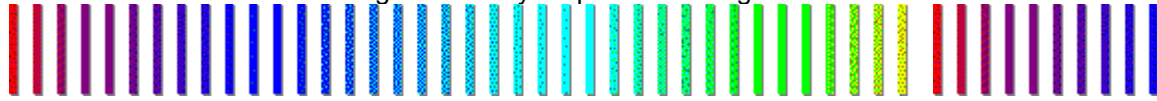

go to Dr. DeskJet for troubleshooting suggestions

[Go to Dr. DeskJet](#)

If you are unable to determine the cause of failure, contact your local dealer or nearest HP Sales and Support Office for instructions on returning your printer for service and repair.

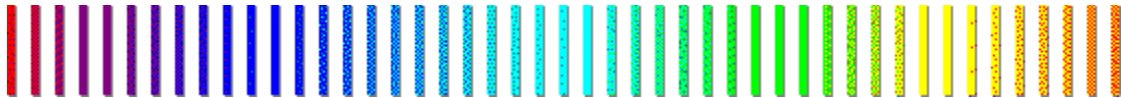



Index

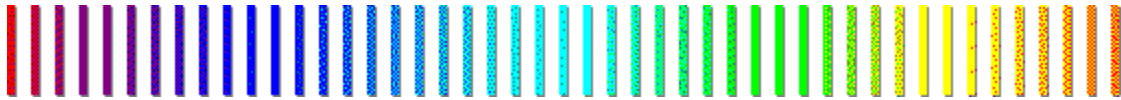

A

- [About HP DeskJet Status Monitor command \(Help menu\)](#)
- [Adding paper and other media](#)
- [Align Print Cartridges command](#)
 - [aligning print cartridges](#)
- [Maintenance menu](#)
- [Audio Tips](#)
- [Australia, HP services in](#)
- [Automatic option](#)
 - [ColorSmart dialog box](#)
 - [ColorSmart printer driver](#)
 - [selecting](#)

B

- [Best printing](#)
- [Black printing vs. color printing](#)
- [Blinking lights](#)
- [Buttons, printer](#)
 - [checking](#)
 - [cleaning print cartridges](#)
 - [described](#)

C

- [Cable connection \(Test menu\)](#)
- [Canada, HP services in](#)
- [Cancel Button, Status Monitor window](#)
- [Canceling current print job](#)
- [Cards](#)
 - [card guide](#)
 - [loading paper and other media](#)
 - [weight](#)
- [Cartridges, print. See Print cartridges](#)
- [Changing print cartridges](#)
- [Checkup, performance](#)
- [Choosing color](#)
- [Clean Print Cartridge command](#)
 - [cleaning print cartridges](#)
 - [Maintenance menu](#)
- [Collating \(Ordered printing\)](#)
- [Color](#)
 - [choosing](#)
 - [ColorSmart](#)
 - [Automatic vs. Manual options](#)
 - [described](#)
 - [dialog box](#)

[printer driver](#)
[grayscale printing of color documents](#)
[HP Color Kit](#)
 [described](#)
 [print cartridges](#)
 [using](#)
 [matching screen](#)
 [ColorSmart Options dialog box](#)
 [ICM \(Image Color Matching\)](#)
 [selecting](#)
 [ColorSmart Options dialog box](#)
 [using](#)
 [vs. black printing](#)
 [when and where to use](#)
Color Control
 [ColorSmart printer driver](#)
 [ColorSmart Options dialog box](#)
 [selecting](#)
Color Kit
 [described](#)
 [print cartridges](#)
 [using](#)
Color wheel
ColorSmart
 [Automatic vs. Manual options](#)
 [described](#)
 [dialog box](#)
 [printer driver](#)
CompuServe
 [Canada](#)
 [Europe](#)
 [United States](#)
Configuration (Test menu)
Connections
 [listing connected printers \(Printer menu\)](#)
 [testing \(Test menu\)](#)
Contents command (Help menu)
Copies
Custom paper size
 [ColorSmart dialog box](#)
 [described](#)
[Customer services from HP](#)
D
[Darker printing \(Intensity\)](#)
[Designing with color \(Choosing color; When and where to use color\)](#)
[DeskJet printers. See Printer](#)
[Dialog boxes](#)
[Direction of printing \(Landscape; Portrait\)](#)
[Dots missing](#)
Downloading HP information
 [Australia](#)
 [Canada](#)
 [New Zealand](#)
 [United States](#)
[Dr. DeskJet](#)

Draft quality
[EconoFast](#)
[Grayscale](#)
Driver, printer [See Printer driver](#)

E

[EconoFast](#)
[ColorSmart dialog box](#)
[using](#)
[Envelopes](#)
[described](#)
[loading paper and other media](#)
[supported types](#)
[weight](#)
[Europe, HP services in](#)

F

Faster printing [See EconoFast; Performance](#)
Faxed help from HP
[Australia](#)
[Canada](#)
[Europe](#)
[New Zealand](#)
[United States](#)

Fonts

[memory usage affects performance](#)
[TrueType](#)

G

Glossy paper
[selecting](#)
[supported types](#)
[Grayscale](#)
[ColorSmart dialog box](#)
[described](#)

H

Halftoning
[ColorSmart printer driver](#)
[ColorSmart Options dialog box](#)
[selecting](#)
Hardware repair service
[Australia](#)
[Canada](#)
[Europe](#)
[New Zealand](#)
[United States](#)

Help

[See also Problems; Tips](#)
[from HP](#)
[Australia](#)
[Canada](#)
[Europe](#)
[New Zealand](#)
[United States](#)
[worldwide](#)
[Status Monitor Help](#)
[Help menu, Status Monitor window](#)

[Hewlett-Packard \(HP\) services](#)

[Highest quality \(Best printing\)](#)

[Hints See Tips](#)

[HP Audio Tips](#)

[HP Color Kit](#)

[described](#)

[print cartridges](#)

[using](#)

[HP ColorSmart](#)

[Automatic vs. Manual options](#)

[described](#)

[dialog box](#)

[printer driver](#)

[HP customer services](#)

[HP DeskJet 600 Series printers See Printer](#)

[HP DeskJet Status Monitor](#)

[aligning print cartridges](#)

[cleaning print cartridges](#)

[described](#)

[window](#)

[HP Download Service](#)

[Australia](#)

[Canada](#)

[New Zealand](#)

[United States](#)

[HP FIRST Fax](#)

[Australia](#)

[Canada](#)

[Europe](#)

[New Zealand](#)

[United States](#)

[HP Premium papers](#)

[selecting](#)

[supported types](#)

[HP services](#)

[Hues](#)

[See also Color](#)

[selecting](#)

I

[ICM \(Image Color Matching\)](#)

[IN tray](#)

[envelopes](#)

[paper and other media](#)

[Ink](#)

[cartridges See Print cartridges](#)

[controlling amount \(Intensity\)](#)

[saving](#)

[EconoFast](#)

[Grayscale printing](#)

[InkJet paper](#)

[selecting](#)

[supported types](#)

[Installing](#)

[paper and other media](#)

[print cartridges](#)

Intensity

- [ColorSmart printer driver](#)
- [ColorSmart Options dialog box](#)
- [selecting](#)

Internet

- [Canada](#)
- [Europe](#)
- [United States](#)

J

- [Jammed paper](#)

K

L

- [Landscape](#)
- [Last page first \(Ordered printing\)](#)
- [Late-breaking information \(Release notes\)](#)
- [Length of paper](#)
- [Lengthwise printing \(Landscape\)](#)
- [Lighter printing \(Intensity\)](#)
- [Lights, printer](#)
 - [blinking](#)
 - [checking](#)
 - [described](#)
- [Lines missing](#)
- [Listing connected printers \(Printer menu\)](#)
- [Loading](#)
 - [envelopes](#)
 - [paper and other media](#)

M

- [Maintenance menu, Status Monitor window](#)
- Maintenance
 - [checkup](#)
 - [print cartridges](#)
 - [Status Monitor window](#)
- [Manual option](#)
 - [ColorSmart dialog box](#)
 - [ColorSmart printer driver](#)
 - [selecting](#)
- [Manually feeding \(loading\) an envelope](#)
- Match Screen
 - [ColorSmart Options dialog box](#)
 - [selecting](#)
- Media
 - See also* [Envelopes; Paper; Transparencies](#)
 - [loading](#)
 - [selecting type](#)
 - [supported types](#)
 - [weight](#)
- [Memory](#)
- [Missing lines or dots](#)
- [Monitor](#) *See* [Status Monitor](#)

N

- [New Zealand, HP services in](#)
- [Normal print quality](#)

O

[Optimizing printer performance](#)
[Ordered printing](#)
[Orientation \(Landscape; Portrait\)](#)
[Overhead slides](#)

P

Paper

[installing](#)
[jams](#)
[loading](#)
size
 [custom](#)
 [selecting](#)
types
 [ColorSmart dialog box](#)
 [selecting](#)
 [supported](#)
[weight](#)

Pattern halftoning

[ColorSmart Options dialog box](#)
[selecting](#)

Performance

[See also EconoFast](#)
[checkup](#)
[increasing](#)
[optimizing](#)

[Portrait](#)

[Power button](#)

[checking](#)
[cleaning print cartridges](#)
[described](#)

[Power light](#)

[checking](#)
[described](#)

Premium papers

[selecting](#)
[supported types](#)

[Presentation slides](#)

[Print a Self Test command \(Test menu\)](#)

[Print cartridges](#)

[aligning](#)
[changing](#)
[cleaning](#)
[color printing vs. black printing](#)
[described](#)
[EconoFast saves ink](#)
[HP Color Kit](#)
[installing](#)
[maintenance](#)

[Print in Grayscale](#)

[ColorSmart dialog box](#)
[described](#)

[Printer](#)

[See also Printing](#)
[buttons](#)

- [checking](#)
 - [cleaning print cartridges](#)
 - [described](#)
- [cable connection \(Test menu\)](#)
- [cartridges See Print cartridges](#)
- [configuration \(Test menu\)](#)
- [described](#)
- [does not print](#)
- [fonts provided with printer](#)
- [lights](#)
 - [checking](#)
 - [described](#)
- [listing connected printers \(Printer menu\)](#)
- [monitoring See Status Monitor](#)
- [performance](#)
 - [checkup](#)
 - [increasing](#)
 - [optimizing](#)
- [repair service](#)
 - [Australia](#)
 - [Canada](#)
 - [Europe](#)
 - [New Zealand](#)
 - [United States](#)
- [self-test](#)
 - [performance checkup](#)
 - [Test menu](#)
- [software](#)
 - [See also Printer driver; Software](#)
 - [described](#)
 - [updating](#)
- [turning off](#)
 - [Power button](#)
 - [print cartridges should return before unplugging](#)

[Printer driver](#)

- [See also Software](#)
- [ColorSmart](#)
- [described](#)
- [performance](#)
- [updating](#)
 - [Australia](#)
 - [Canada](#)
 - [Europe](#)
 - [New Zealand](#)
 - [United States](#)

[Printer menu, Status Monitor window](#)

[Printer Status Box, Status Monitor window](#)

[Printing](#)

- [See also Printer](#)
- [cancel current print job](#)
- [monitoring See Status Monitor](#)
- [printer does not print](#)
- [problems](#)
 - [Dr. DeskJet](#)
 - [help from HP](#)
 - [performance checkup](#)

[printer does not print](#)
[self test \(Test menu\)](#)
[tips](#)

[Problems](#)

[See also Help; Tips](#)
[Dr. DeskJet](#)
[help from HP](#)
[performance checkup](#)
[printer does not print](#)

Q

R

[RAM](#)

[README file \(Release notes\)](#)

[Release notes](#)

[Removing print cartridges](#)

[Repair service](#)

[Australia](#)

[Canada](#)

[Europe](#)

[New Zealand](#)

[United States](#)

[Resume button](#)

[checking](#)

[cleaning print cartridges](#)

[described](#)

[Resume light](#)

[checking](#)

[described](#)

[Reverse order of printing \(Ordered printing\)](#)

S

[Scalable TrueType fonts](#)

[Scatter halftoning](#)

[ColorSmart Options dialog box](#)

[selecting](#)

[Screen](#)

[fonts](#)

[performance](#)

[TrueType](#)

[matching colors](#)

[ColorSmart Options dialog box](#)

[ICM \(Image Color Matching\)](#)

[selecting](#)

[Self test](#)

[performance checkup](#)

[Test menu](#)

[Services from HP](#)

[Show Configuration command \(Test menu\)](#)

[Sideways printing \(Landscape\)](#)

[Single Envelope Slot](#)

[Size, paper](#)

[custom](#)

[ColorSmart dialog box](#)

[described](#)

[selecting](#)

Slides

Software

See also Printer driver

color-capable applications

help from HP

Australia

Canada

Europe

New Zealand

United States

performance

printer

described

updating

Special (HP Premium) papers

selecting

supported types

Speed See EconoFast; Performance

Status Monitor

aligning print cartridges

cleaning print cartridges

described

window

Stop printing (Cancel Button)

Storing print cartridges

Support Pack

Supported paper types

T

Technical support services from HP

Test menu, Status Monitor window

Testing printer (self test)

performance checkup

Test menu

Tips

See also Help; Problems

HP Audio Tips

printing tips

Transparencies

See also Paper

described

loading

selecting

supported types

Tray

loading envelopes

loading paper

Troubleshooting See Problems

TrueType fonts

Turning off printer

Power button

print cartridges should return before unplugging

Typefaces

Types of paper

ColorSmart dialog box

selecting

supported

U

United States, HP services in

Updating

printer driver

Australia

Canada

Europe

New Zealand

United States

printer software

Using HP DeskJet Status Monitor command (Help menu)

V

Vivid color

ColorSmart Options dialog box

selecting

W

Warranty service

Australia

Canada

Europe

New Zealand

United States

worldwide

Weight, media

Width of paper

Windows

X

Y

Z

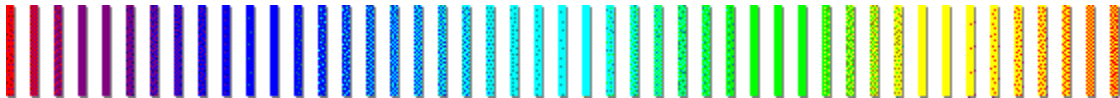

Printer Out of Paper

The printer is out of paper. For instructions on loading paper or other media in your printer, refer to the label inside the printer top cover or see the user's guide for your printer.

When you have finished loading paper, press the **Resume** button on the front of the printer to continue printing.

Paper Jam

The printer has a paper jam. Perform the following steps to clear the paper jam:

- 1.** Open the top cover and remove the OUT tray.
- 2.** Pull the jammed paper out of the printer in the direction the paper feeds through the printer.
- 3.** Remove all torn pieces of paper from the paper path. Small scraps of paper left within the printer can cause additional paper jams.
- 4.** Remove wrinkled or torn paper from the IN tray and reload the paper stack.
- 5.** Replace the OUT tray and close the top cover.
- 6.** Turn the printer off, then on again.

Printer Port Problem

There is a problem accessing the printer port. Try the following suggestions to correct this problem:

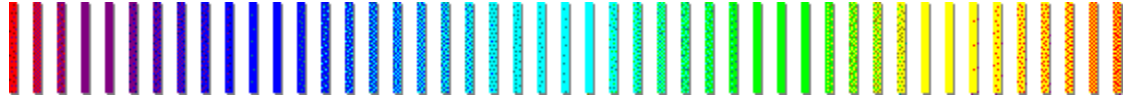

Some other software program may be printing to the same printer port. Click **Cancel** and wait for the other software program to complete printing. Then try printing your document again.

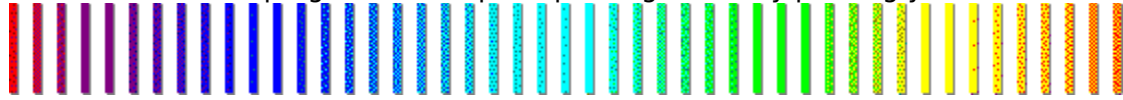

If you have another device such as a tape backup unit attached to the same port, it may be using the port. Click **Cancel** and wait until the other device is finished using the port. Then try printing your document again.

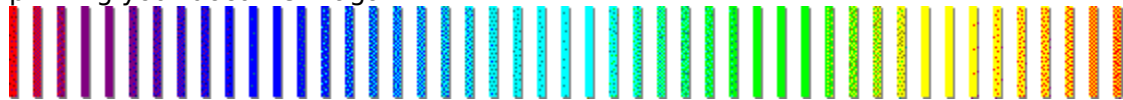

Make sure your printer is connected to the port selected in the Windows Control Panel.

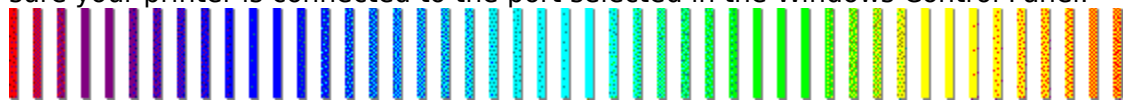

Close all software programs and restart Windows.

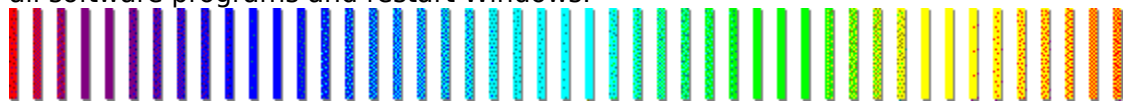

Turn off your computer, then turn the computer on again.

If one of the above steps does not fix the problem, you may have a hardware failure. See the user's guide for your printer for information about customer support services.

Printer Communication problem

The computer cannot establish two-way (bi-directional) communication with your printer. The printer uses bi-directional communication to exchange information with the computer.

You may have one of the following problems:

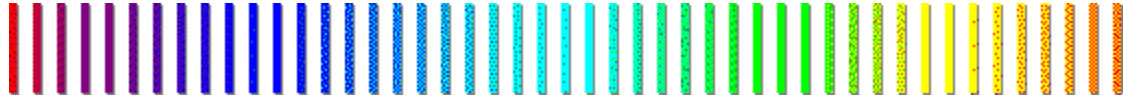

The printer is turned off.

Make sure the printer is turned on.

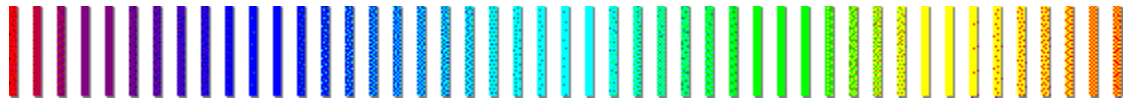

Printing Direct to Port is not checked in the Printers Connect dialog box in the Control Panel

To correct this problem, do the following:

1. Double-click the **Control Panel** icon in the Main program group.
2. Double-click the **Printers** icon.
3. Click the **Connect** button in the Printers dialog box.
4. Check the **Fast Printing Direct to Port** checkbox.

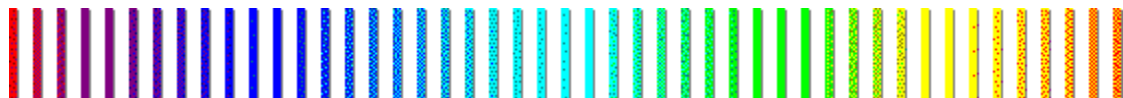

The printer cable may be defective.

Try using a different printer cable.

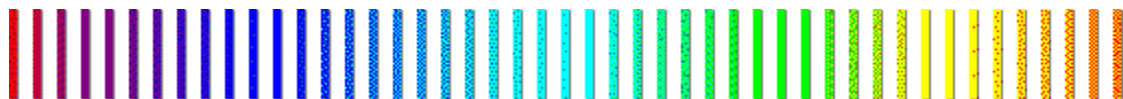

If you are using a switch box, your switch box may not support bi-directional (two-way) communication, or another device may be using the status lines.

Try connecting your printer directly to the computer.

If you must use a switchbox, run the **HPFCFG02.EXE** program in the **C:\WINDOWS** directory. Uncheck the Bi-directional Communication checkbox, then click **OK**. This reconfigures the communication between your printer and your computer so that bi-directional communication is disabled. Note that some printer functions will no longer work.

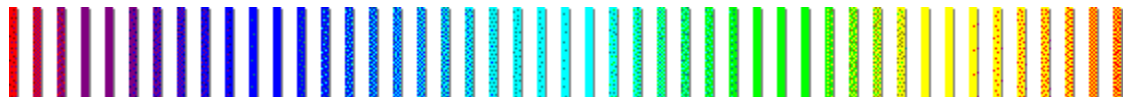

Your computer may not have the hardware required to support two-way (bi-directional) communications.

Run the **HPFCFG02.EXE** program in the **C:\WINDOWS** directory. Uncheck the Bi-directional Communication checkbox, then click **OK**. This reconfigures the communication between your printer and your computer so that bi-directional communication is disabled. Note that some printer functions will no longer work.

Printer Not Responding

The printer is not responding to the printer software. Try the following suggestions to fix the problem:

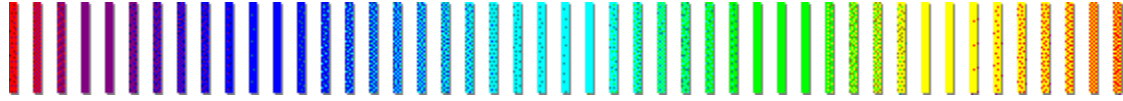

Make sure the printer is turned on.

Make

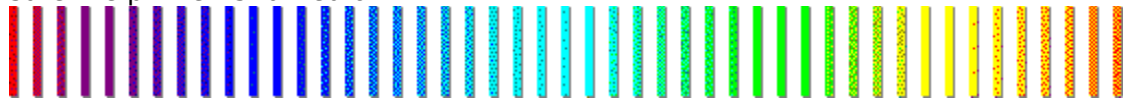

If the printer is off-line, press the **Resume** button to start printing.

If the

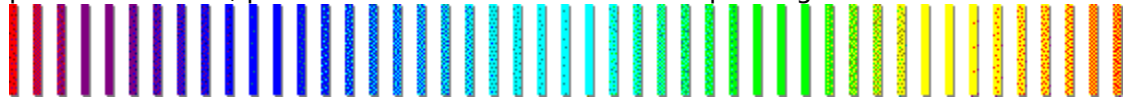

Check for a paper jam. If you have a paper jam, follow the instructions in the troubleshooting section of the user's guide for your printer.

Check



Make sure the top cover is closed.

Make

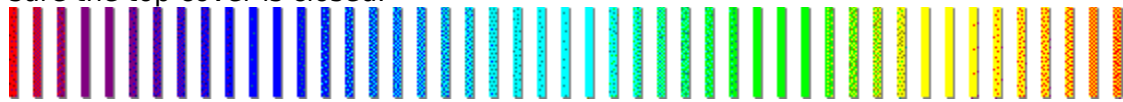

The printer cable may be disconnected or you may have a defective printer cable. Make sure the printer cable is firmly connected to the port on the printer and on the computer.

The

If this does not correct the problem, try a different printer cable.

Change Print Cartridge

The document being printed contains only black or grayscale text and images. Replace the installed print cartridge with a black print cartridge.

If you do not have a black print cartridge, click the **OK** button and continue printing. Your document prints much more slowly in composite black and uses more ink than printing with a black print cartridge.

Follow the instructions in online help or your printers users guide to replace the installed print cartridge with a black print cartridge.

Note: Always store open print cartridges that are not being used in the print cartridge storage container to ensure that the print cartridge does not dry out or clog.

Change Print Cartridge

The document being printed contains color text or images. Replace the installed print cartridge with a color print cartridge. If you do not have a color cartridge, cancel the print job and print the document using the Print in Grayscale setting.

Follow the instructions in the online help or your printers users guide to replace the installed print cartridge with a color print cartridge.

Note: Always store open print cartridges that are not being used in the print cartridge storage container to ensure that the print cartridge does not dry out or clog.

Clean Print Cartridge

The printer cannot identify the installed print cartridge. Try the following suggestions:

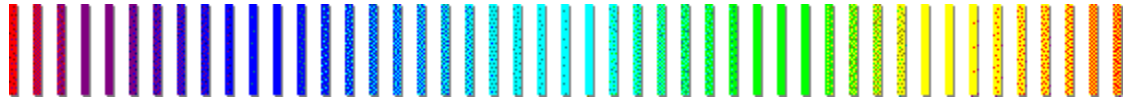

Make sure you are installing a print cartridge with a green cap.

Make

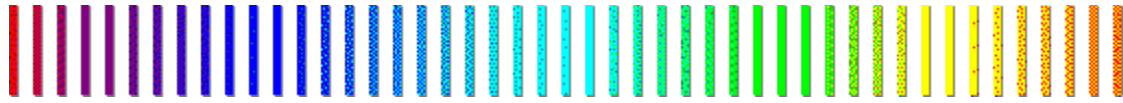

Try re-installing the print cartridge. There may be a bad connection.

Try re-

Follow the instructions in the online help or your printers users guide to replace the print cartridge.

Note: The document being printed contains color text or images. Replace the installed print cartridge with a color print cartridge.

Clean Print Cartridge

The printer cannot identify the installed print cartridge. Try the following suggestions:

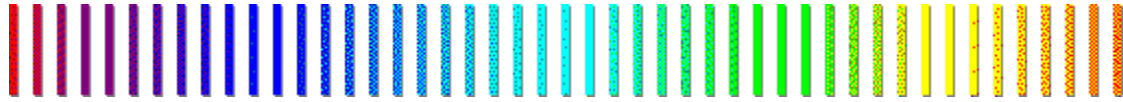

Make sure you are installing a print cartridge with a green cap.

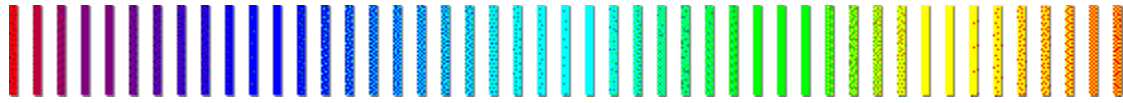

Try re-installing the print cartridge. There may be a bad connection.

Follow the instructions in the online help or your printers users guide to replace the print cartridge.

Note: The document being printed contains only black or grayscale text and images. Replace the installed print cartridge with a black print cartridge.

Improper Power Off

The last time the printer was used, it was improperly turned off.

Use the **Power** button on the front of the printer to turn the printer off.

If the printer is turned off from a power strip switch or by pulling the power cord from the outlet while the printer is printing or the top cover is open, the print cartridge cradle will not return to the home position. This causes the print cartridges to dry out and possibly become damaged.

To avoid this message, make sure the printer has completely stopped printing and is quiet before shutting off power to the printer from any source other than the power button on the front of the printer.

If your print quality has deteriorated since the last time you used the printer, run the Clean Print Cartridge... procedure from the Maintenance menu in the HP Deskjet Status Monitor.

Mechanism Error

There may be a paper jam or other obstruction in the path of the print cartridge. If paper is not jammed in the printer, remove anything else that may be in the path of the print cartridge cradle. Turn the printer off, then on again.

If paper is jammed in the printer, do the following:

- 1.** Open the top cover and remove the OUT tray.
- 2.** Pull the jammed paper out of the printer in the direction the paper feeds through the printer.
- 3.** Remove all torn pieces of paper from the paper path. Small scraps of paper left within the printer can cause additional paper jams.
- 4.** Remove wrinkled or torn paper from the IN tray and reload the paper stack.
- 5.** Replace the OUT tray and close the top cover.
- 6.** Turn the printer off, then on again.

Out of Disk Space

The printer driver uses an area of disk space to temporarily store information while it is processing a document for printing. The area to which it will attempt to temporarily store the information is usually **c:\tmp** or **c:\temp**. Try deleting the files in these directories.

If you are using the **Copies** option and/or the **Ordered Printing** option, this will also cause the driver to require more disk space. Try printing only one copy and/or turning Ordered Printing off.

Another possible way to solve this problem is to turn off **Print Manager**.

Spooling Error

Turn off the **Print Manager** and try printing again.

To turn off the **Print Manager**, do the following:

1. Go to the **Control Panel** and double click on the **Printers** icon.
2. Uncheck the box labeled Use Print Manager.
3. Click the **Close** button.
4. Try printing again.

This will cause the print job to be printed in the foreground instead of sending it to the Print Manager. You will not be able to return to your software program until the print job is complete.

